

WHY ARE WE INCLUDING A FIRED CARTRIDGE CASE WITH EVERY RUGER PISTOL AND REVOLVER?

Certain states and jurisdictions now require that all newly manufactured pistols and revolvers must be accompanied by a cartridge case, which has been test fired from that gun at the factory. The case must be placed in a sealed container bearing certain information concerning this test cartridge.

At the time of retail sale in those jurisdictions, firearms dealers must forward such test cartridge to a designated destination such as their State Police Laboratory. As independent Ruger Distributors have nationwide markets without territorial restrictions, we have decided to include a fired cartridge case with all new Ruger pistols and revolvers, to minimize the possibility of inadvertent non-compliance with these laws.

Retail customers located in other states, where laws or regulations do not require the dealer to so act, may be assured that the fired cartridge case they receive with the firearm at the time of retail purchase is proof that your new Ruger firearm has undergone our normal test firing procedures during manufacture.



WARNING – LOCKING DEVICES



**DO NOT INSTALL
INSIDE TRIGGER GUARD**

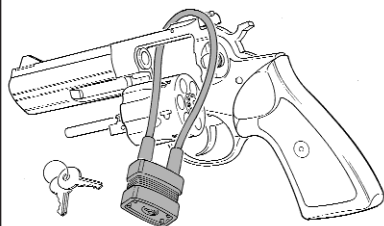

**INSTALL LOCK
AS SHOWN HERE**

This firearm was originally sold with a key-operated locking device. While it can help provide secure storage for your **unloaded** firearm, any locking device can fail. All guns are designed to fire if they are loaded and the trigger is pulled. Therefore, **never install the locking device inside the trigger guard or in any way that it can possibly pull the trigger!** Do not leave the keys in the lock.

The ultimate responsibility for secure storage of any firearm must depend upon its owner and his or her individual circumstances. **Guns should be securely stored unloaded, in a secure location, separate from their ammunition.**

See “Storage Warning”, page 16.

**NEVER INSTALL
LOCKING DEVICE
INSIDE TRIGGER GUARD**

FIREARMS SAFETY-YOUR RESPONSIBILITY

SAFETY MUST BE THE FIRST AND CONSTANT CONSIDERATION OF EVERY PERSON WHO HANDLES FIREARMS AND AMMUNITION.

This Instruction Manual is designed to assist you in learning how to use and care for your **RUGER® SUPER REDHAWK** revolver properly.

Only when you are certain you fully understand the Manual and can properly carry out its instructions should you practice loading, unloading, etc. with live ammunition. If you have any doubts about your ability to handle or use a particular type of gun safely, then you should seek supervised instruction. Such personalized instruction is often available from gun dealers, gun clubs or police departments. If none of these sources can help you, write to the National Rifle Association, 11250 Waples Mill Road, Fairfax, VA 22030-7400. They will put you in touch with a source of personalized instruction.

The person possessing a gun has a full-time job. You cannot guess; you cannot forget. You must know how to use your firearm safely. **Do not use any firearm without having a complete understanding of its particular characteristics and safe use.** Remember: There is no such thing as a foolproof gun.

TABLE OF CONTENTS

	Page
General Information and Mechanical Characteristics	4
Ammunition	6
Handling	7
To Load and Fire	8
To Uncock (Decock) The Revolver	10
To Unload or Eject Cartridge Cases	11
Disassembly	13
Reassembly	14
Care and Cleaning	15
Storage	16
Care of Stainless Steel Revolvers	17
Attaching Ruger Scope Rings	17
Sights	18
Service and Parts Policy	19
Parts Drawing	25
The Basic Rules of Safe Firearms Handling	27
Warranty Information	32

“Ruger”, “Redhawk” and the Sturm, Ruger logo are registered U.S. trademarks.



WARNINGS OF GREAT IMPORTANCE ARE FOUND ON THE FOLLOWING PAGES:

Locking Devices	2	Firing	10
Alterations	4	Disassembly	12
Lead Exposure	6	Lubrication	15
Ammunition	6	Storage	16
Handling	7	Parts Purchasers	20
Cylinder Interlock	8		

OTHER CAUTIONS AND WARNINGS APPEAR THROUGHOUT THE MANUAL.

**FIREARMS ARE DANGEROUS WEAPONS—
READ THE INSTRUCTIONS AND WARNINGS IN THIS
MANUAL THOROUGHLY AND CAREFULLY BEFORE USING.**



WARNING—ALTERATIONS



This product was designed to function properly in its original condition. Alterations can make it unsafe. Do not alter any part or add or substitute parts or accessories not made by Sturm, Ruger & Co. Inc.

DO NOT ALTER ANY GUN

GENERAL INFORMATION AND MECHANICAL CHARACTERISTICS

The **RUGER® SUPER REDHAWK** revolver is a double-action firearm which is specifically designed for hunting and target shooting with heavy Magnum cartridges and embodies many features found in the famous **RUGER® REDHAWK®** and **RUGER® GP100®** revolvers. It is the second of an entirely new generation of Ruger double-action revolvers. The unique frame extension permits the use of full wrap-around style grips of any desired configuration. This feature reduces overall weight and contributes to a desirable muzzle of heaviness. The crane and cylinder assembly of the Super Redhawk revolver locks directly into the frame, both at the rear of the cylinder and at the front of the crane. The ejector rod serves only as an ejector – it does not rotate with the cylinder. All of this mechanism is readily removable without tools and dismantles, along with the cylinder/crane group, into a small number of subassemblies for inspection and cleaning (See Figure 2, pg. 5).

The internal parts are installed either through the top or bottom of the grip-frame; therefore, *no side plate* is needed. The resulting *double solid frame* contributes greatly to the extraordinary strength and reliability of these revolvers. The massive extended frame and use of Ruger integral scope mounting system on the wide top strap provide a solid scope mounting system.

The **RUGER® SUPER REDHAWK** revolver has a transfer bar which is connected directly to the trigger. The transfer-bar safety system provides that the hammer blow can be transmitted to the firing pin only when the trigger is pulled all the way to the rear. This is a positive internal safety feature.

Ruger Super Redhawk revolvers chambered for the .454 Casull and .480 Ruger cartridges have unfluted cylinders.

NOMENCLATURE

Figure 1.

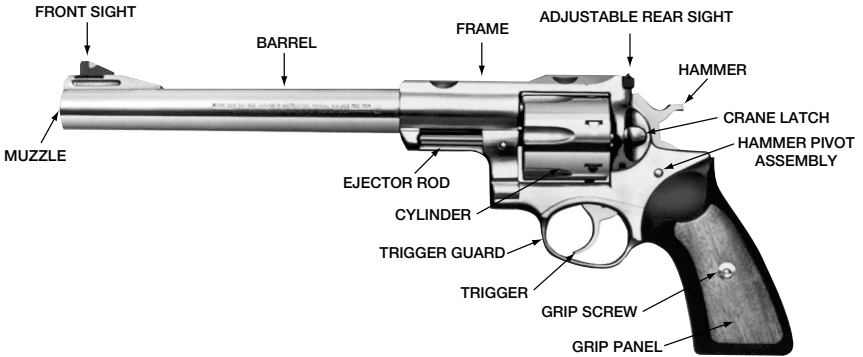
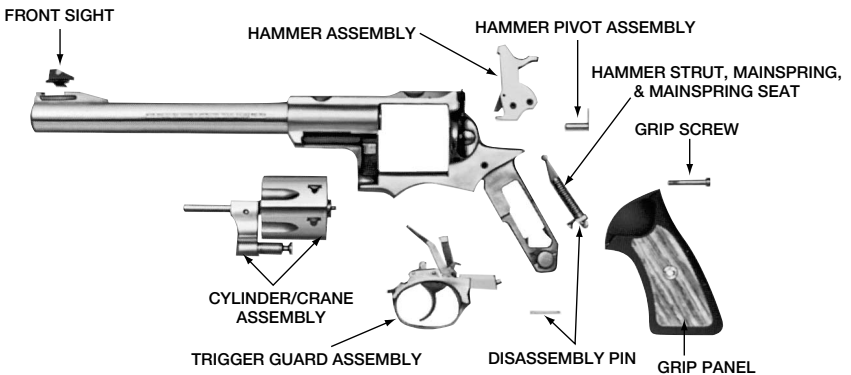

Figure 2.



Despite their many highly desirable features, Ruger revolvers—as with all firearms—must at all times be handled with strict attention to correct safety practices, and be inspected frequently to assure the gun is working properly.



WARNING – LEAD EXPOSURE



Discharging firearms in poorly ventilated areas, cleaning firearms, or handling ammunition may result in exposure to lead and other substances known to the state of California to cause birth defects, reproductive harm, and other serious physical injury. Have adequate ventilation at all times. Wash hands thoroughly after exposure.

**SHOOTING OR CLEANING GUNS
MAY EXPOSE YOU TO LEAD**

AMMUNITION

RUGER® SUPER REDHAWK revolvers in caliber .44 magnum will chamber the .44 Rem. Magnum cartridge and the .44 S&W Special cartridge. Ruger Super Redhawk revolvers chambered for the .454 Casull will chamber the .454 Casull and the .45 Colt cartridges. Revolvers chambered for the .480 Ruger cartridge should be used only with ammunition of that specific caliber. The correct caliber is marked on each revolver. Ruger revolvers are designed for use with cartridges of the correct caliber which are manufactured in accordance with the U.S. Industry Standards. Be certain to use proper cartridges of the correct caliber. See “Care and Cleaning,” p. 15, for important information on chamber cleaning.



WARNING – AMMUNITION



Death, serious injury, and damage can result from the use of wrong ammunition, bore obstructions, powder overloads, or incorrect cartridge components. Always wear shooting glasses and hearing protectors.

**IMPROPER AMMUNITION
DESTROYS GUNS**

AMMUNITION (CARTRIDGES) NOTICE

WE SPECIFICALLY DISCLAIM RESPONSIBILITY FOR ANY DAMAGE OR INJURY WHATSOEVER OCCURRING IN CONNECTION WITH, OR AS THE RESULT OF, THE USE IN THE SUPER REDHAWK REVOLVER OF FAULTY, OR NON-STANDARD, OR "RE-MANUFACTURED", OR HAND LOADED (RELOADED) AMMUNITION, OR OF CARTRIDGES OTHER THAN THOSE FOR WHICH THE FIREARM WAS ORIGINALLY CHAMBERED.

HANDLING

CARRYING: The Super Redhawk revolver can be carried with all chambers loaded. When the hammer and trigger are fully forward, the transfer-bar is lowered out of its firing position and the hammer rests directly on the frame.

 WARNING – HANDLING	
	<p>If the trigger is held to the rear, the gun can fire if the hammer strikes the transfer bar. Note that it need not be a deliberate effort to pull the trigger. Any situation where the trigger attains its rearward position and permits the transfer bar to be interposed between the hammer and the firing pin can cause the cartridge under the firing pin to discharge.</p> <p>NEVER DROP OR STRIKE THE REVOLVER – COCKED OR UNCOCKED CARRY AND HANDLE THE REVOLVER IN SUCH A MANNER THAT THE HAMMER AND TRIGGER WILL NOT BE STRUCK.</p>
<p>NEVER CARRY ANY REVOLVER WITH THE HAMMER COCKED OR THE TRIGGER HELD TO THE REAR</p>	

DRY-FIRING

“Dry Firing” is practicing the trigger pull of the empty revolver for practice and familiarity. The Super Redhawk revolver can be dry-fired without damage to the firing pin or internal components.

Be sure that the revolver is unloaded before handling. Be sure of your bullet stop, even when dry-firing for practice. Do not dry-fire the revolver with the plastic ‘safety disc’ on the cylinder.

TO LOAD AND FIRE

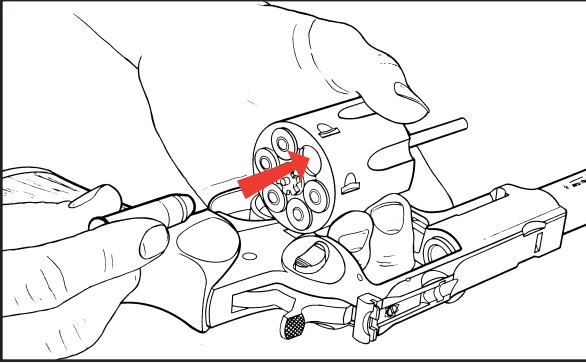

Be sure the revolver is pointed in a safe direction and is never cocked while loading.

1. Press the crane latch and guide cylinder out of frame to the left to its loading position (See Figure 3).

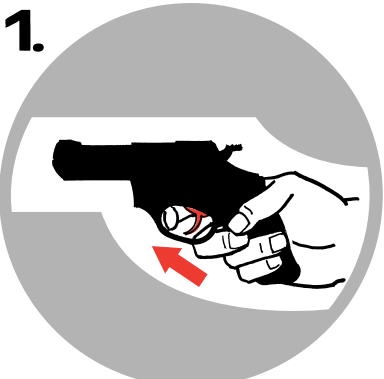



**FIGURE 3
LOADING THE
REVOLVER.**

2. Insert cartridges and gently close cylinder, making sure it is securely latched. Do not “flip” the cylinder open or shut.

 WARNING – CYLINDER INTERLOCK	
	When correctly operated, the cylinder cannot be opened when the hammer is cocked, and the hammer/trigger mechanism is not able to be operated until the cylinder is locked shut. However, this safety interlock can be intentionally defeated if the crane latch is depressed and the hammer is then cocked while the cylinder opened. If the cylinder is then shut when the hammer is cocked, the hammer may fall and the gun may fire.
	NEVER CLOSE OR OPEN THE CYLINDER WHILE THE HAMMER IS COCKED

3. The revolver is now ready to fire, either “double-action” by pulling the trigger through its complete arc for each shot, or “single-action” by cocking the hammer and then pulling the trigger for each shot. The trigger pull is somewhat shorter and lighter when the revolver is fired single action, and this is the preferred mode for precise shots or target shooting
4. **DO NOT TOUCH THE TRIGGER UNTIL YOU ARE READY TO FIRE.**

 CAUTION-DOUBLE ACTION FIRING		
1.		<p>When firing in the double action mode, be sure that the trigger is released completely to its fully forward position before pulling the trigger for a subsequent shot. If the trigger finger is allowed to interfere with the full recovery of the trigger (preventing it from moving through about the last one-eighth inch of its forward movement), the trigger cannot be pulled again for another discharge. The trigger must be fully released after each shot is fired. This characteristic is found in all modern double-action revolvers and “double-action only” pistols.</p>
2.		
FULLY RELEASE TRIGGER BETWEEN SHOTS		

5. **DO NOT HOLD THE REVOLVER BY THE BARREL OR CYLINDER WHEN FIRING.**



WARNING–FIRING

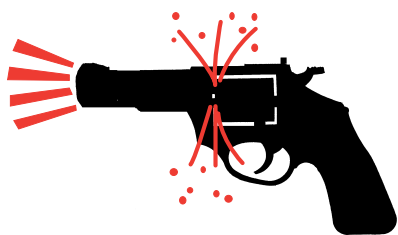

When firing the Super Redhawk revolver, be sure all persons are a safe distance to the rear of the shooter. When fired, all revolvers discharge hot gas and particles of lead, powder grains, or lubricant through the clearance gap between the cylinder and the rear of the barrel at high speed. This can injure a person who is standing too close to the revolver.

When firing the Super Redhawk revolver (or any revolver), always be certain that nothing – including your hands – is in the path of the hot gas and particles which are discharged from the front and sides of the cylinder.

When shooting, adequate eye protection is essential. Shooters and bystanders must wear shooting glasses. Hearing protection must also be worn. Exposure to shooting noise can damage hearing.



**HOT GASES EXIT
BARREL/CYLINDER GAP**

TO UNCOCK (DECOCK) THE REVOLVER

If your revolver is cocked, and you wish to let the hammer down to its forward position (against the frame), proceed as follows: **USE EXTREME CARE WHEN ATTEMPTING TO DECOCK THE REVOLVER, AS THE THUMB SLIPPING DURING THIS PROCESS CAN RESULT IN AN ACCIDENTAL DISCHARGE IF THE TRIGGER IS HELD TO THE REAR.**

1. **Make certain that the revolver is pointed in a safe direction** (See Rule 2, Page 27).
2. Make certain both hands are dry and not impeded in any way – gloves, bandages, cold, etc.
3. Grasp the revolver (if right handed) so that the thumb and forefinger of your left hand are firmly holding the frame, forward of the trigger guard. Thus, your left hand is in full control of the revolver (See Figure 4A, Page 11).
4. Place your right thumb firmly on the hammer spur and, with your thumb securely in control of the hammer, squeeze the trigger only enough to permit the hammer to ‘break free’ of the trigger. At that instant, **IMMEDIATELY RELEASE THE TRIGGER** and then slowly permit the hammer, **STILL SECURE UNDER YOUR THUMB**, to move fully forward to its resting position against the frame. **NOTE:** It is imperative that finger pressure be removed from the trigger just as soon as it is free of the hammer. Then, properly, the trigger and hammer will move towards their fully forward rest positions together (See Figure 4B, Page 11).

Practice this important gun handling skill with an unloaded revolver until you have developed the proper control and 'touch' to decock your revolver safely. The key to safe decocking is having the weight of the revolver controlled with one hand, while the thumb and forefinger of the 'shooting hand' control the hammer and trigger. Improperly restraining the trigger during this procedure may result in the hammer not resting fully against the frame. If this should occur, carefully repeat the procedure for decocking, steps 1–4 again.

UNCOCKING THE REVOLVER

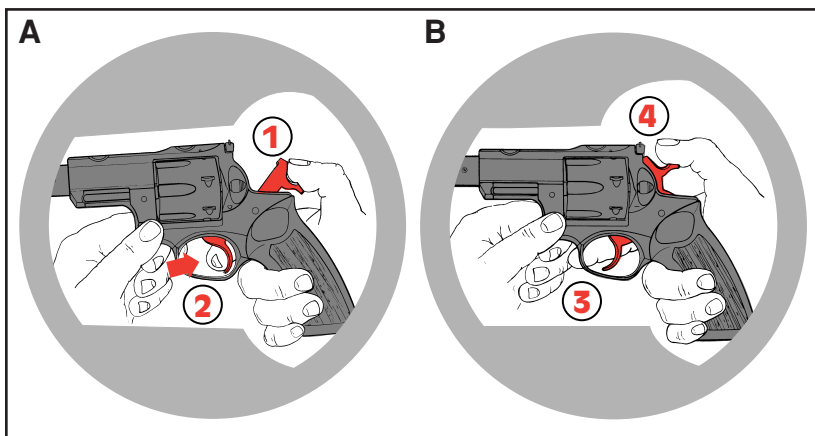

FIGURE 4

A. With the thumb controlling the hammer as shown (1), squeeze trigger to permit hammer to 'break free' (2).

B. When hammer is free, IMMEDIATELY release trigger (3). Then lower hammer slowly to its resting position completely down against frame (4).

TO UNLOAD OR EJECT CARTRIDGE CASES

**KEEP THE REVOLVER POINTED IN A SAFE DIRECTION!
DO NOT ATTEMPT TO UNLOAD WHEN THE HAMMER IS COCKED.**

1. Uncock the revolver (See pp. 10 - 11).
2. Press crane latch. Guide cylinder out left of frame as for loading. The revolver now cannot be fired.
3. Push head of ejector rod smartly toward rear of cylinder until it stops. This action will extract cartridges or fired cases. Do not eject live cartridges onto any surface where a primer might strike a solid object and discharge the cartridge.
4. **Check to be sure all chambers are empty.**

NOTE: When ejecting fired cartridge cases, position the revolver at a high angle so the cases will come fully out of the chambers and not slip under the ejector. This high angle positioning is not necessary when ejecting unfired cartridges.

CORRECT UNLOADING SEQUENCE

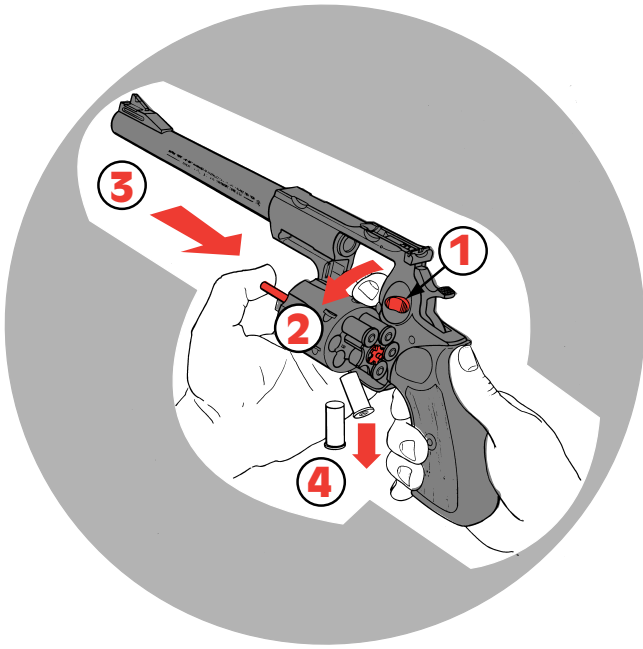

WARNING – DISASSEMBLY



Always unload a firearm before cleaning, lubrication, disassembly or assembly.

Never remove or install a loaded cylinder – it can fire if dropped or struck.

UNLOAD BEFORE CLEANING

DISASSEMBLY

Read instructions before disassembling a gun.

1. BE CERTAIN THE REVOLVER IS UNLOADED BEFORE DISASSEMBLY.

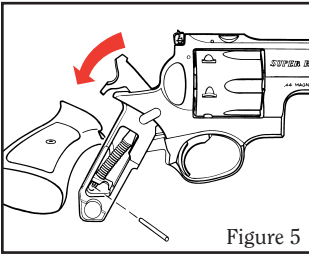

2. Using a properly fitting screwdriver, remove grip screw. Remove pistol grip inserts from grips. Grip panel locator may then be removed. Pull grip downward off frame. Take care not to lose the disassembly pin, which may fall free when the grip is removed (See Figure 5).

3. Cock the hammer. Insert disassembly pin about one half its length into the hole at the rear of the mainspring strut. Lacking a

disassembly pin, any similar instrument will serve.

4. With thumb on hammer spur, squeeze trigger allowing hammer to go fully forward. Lift out mainspring assembly. CAUTION: Do not remove the disassembly pin until the mainspring assembly is reinstalled in the revolver at the time of reassembly. Doing so will permit the mainspring to fly off its strut with great force and may cause injury.

5. Pull trigger and remove hammer pivot while holding trigger in a rearward position. Lift hammer out of the top of the frame while trigger is held in a rearward position (See Figure 6).

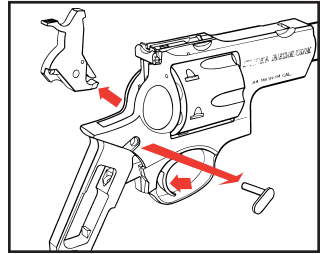

6. Use mainspring assembly to depress trigger guard lock plunger located inside frame at rear of trigger guard. Simultaneously pull down and remove trigger guard assembly (See Figures 7 & 8).

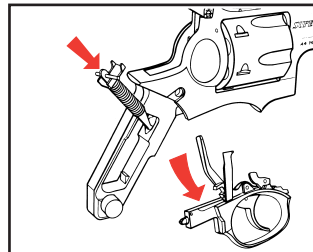
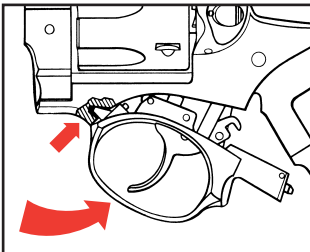

NOTE: If you cannot supply sufficient force to the plunger using the mainspring assembly as a “tool”, then use a screwdriver of appropriate size and insert through hole in frame. It may be necessary to slightly depress the trigger while removing the trigger guard assembly.

7. Cradle the revolver frame in your left hand and with the thumb of your right hand press cylinder latch button, swing out cylinder assembly and remove it forward from the frame.
8. Further disassembly is not essential for normal cleaning purposes. Any further disassembly should only be undertaken by factory service personnel.

REASSEMBLY

AGAIN, BE CERTAIN REVOLVER IS UNLOADED!

Before starting reassembly, be certain that all components and the inside of the frame are thoroughly clean. In particular the tongue on the front of the trigger guard and its mating recess in the frame must be completely clean.

1. Replace cylinder and crane assembly in frame and close cylinder.
2. Hook front of trigger guard into recess in frame (See Figure 7). Align pawl in its recess in the frame and be sure transfer bar is in correct position in rear of firing pin. Swing trigger guard upward into position in frame then allow latch to re-engage. If solid resistance is felt when swinging trigger guard into frame, or if trigger guard will not lock into position re-check position of pawl and transfer bar (See Figure 9).

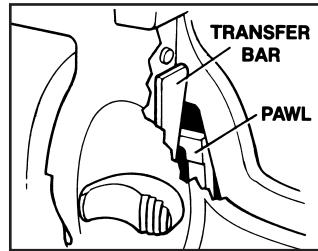

Figure 9

NOTE: At this point in reassembly trigger should function to rotate and lock the cylinder. Pull the trigger a few times, to check proper functioning, as always with the revolver pointed in a safe direction.

3. Hold trigger in its rearward position and insert hammer into frame. Install hammer pivot. Release trigger and permit hammer to go fully forward.
4. With hammer forward, insert mainspring assembly into frame. Position the two ends of notch in the mainspring seat onto the matching projections of the grip frame. (Note: The large notch in the mainspring seat should be forward to allow clearance for the grip screw.) Hold mainspring assembly in position and cock hammer. It may be necessary to move the mainspring assembly a little to properly position the upper end of the mainspring strut to rest in recess in the hammer. When the hammer is cocked, disassembly pin can be removed (It will fall free).
5. Squeeze trigger and ease hammer down. Put the disassembly pin in its “nest.” Push grip upward onto the frame, install grip panel locator and place pistol inserts into position. Install and tighten grip panel screw.
6. Open and close cylinder. Function the trigger and hammer single action and double action to be certain that all parts are working properly.



CARE AND CLEANING

ALWAYS BE CERTAIN THE REVOLVER IS UNLOADED BEFORE CLEANING.

The internal mechanism of the Super Redhawk revolver can be lubricated without disassembly. A few drops of light oil recommended as suitable for firearms, applied periodically about the various frame openings, will work its way into the mechanism parts. The exterior of the revolver and the bore and chambers should be thoroughly cleaned and then wiped with an oily cloth if the gun is to be stored. Do not apply excess lubrication.

To clean the revolver after firing, swing the cylinder out and clean the barrel from the muzzle by running a cleaning rod with a solvent coated patch through the bore several times. A bronze wire brush (of correct size for gun caliber) attached to the cleaning rod should then be pushed the full length of the bore several times. Again swab the bore with a solvent coated patch. Then wipe the rod clean and, using a dry patch, swab the bore until it is clean. Examine the bore to be sure that no fouling remains. Repeat the above procedure for each of the six chambers.

Chambers must be thoroughly scrubbed to remove build-up of bullet metal and firing residue. A dirty chamber can prevent full seating of a cartridge, which in turn causes the cylinder to bind. **DO NOT APPLY EXCESSIVE OIL TO UNDERSIDE OF EJECTOR – AREA SHOULD BE WIPED DRY WITH OILY CLOTH.** Also, the underside of the ejector ('star') and the area of the cylinder where the ejector seats, must be clean. Dirt can prevent the ejector from fully seating. That condition can cause hard closing of the cylinder and interfere with proper cylinder rotation.

 WARNING – LUBRICATION	
	<p>Firing a revolver with oil, grease, or any other material even partially obstructing the bore may result in damage to the revolver and serious injury to the shooter and those nearby.</p> <p>Do not spray or apply lubricants directly on ammunition. If the powder charge of a cartridge is affected by the lubricant, it may not be ignited, but the energy from the primer may be sufficient to push the bullet into the bore where it may become lodged. Firing a subsequent bullet into the obstructed bore may damage the revolver and cause serious injury or death to the shooter and those nearby. Use lubricants properly. You are responsible for the proper care and maintenance of your firearms.</p>
	IMPROPER LUBRICATION DESTROYS GUNS

If lead bullet loads are fired extensively, lead build-up may cause cylinder binding. Lubricate the cylinder crane gap with Break-Free® CLP or some other lubrication which meets mil. spec. Mil-1-63460 to prevent this condition.

STORAGE

GUNS SHOULD NOT BE STORED LOADED!



**USE THE LOCKING DEVICE SUPPLIED WITH THE REVOLVER FOR STORAGE.
(SEE PAGE 2)**

Do not keep your revolver in a leather, fabric or canvas holster when it is stored. These materials attract moisture, even though the holster may appear to be perfectly dry.

TO RENDER THE REVOLVER INOPERATIVE FOR SAFE STORAGE

With the muzzle pointed in a safe direction, press the cylinder latch and swing the cylinder outward. Check to be sure that each chamber is completely unloaded! With a coin or screwdriver, unscrew the grip panels and remove the grips. Cock the hammer and then insert the disassembly pin into the hole at the bottom of the mainspring strut. Uncock the hammer, remove the hammer strut from the frame, remove the hammer pivot from the frame, and lift the hammer out of the top of the frame. Use a screwdriver to depress the trigger housing latch and remove the trigger assembly from the bottom of the frame.

Store the hammer and the trigger assembly in different locations from the frame. When disassembled in this manner, the revolver is inoperable. It is impossible to fire the revolver until the trigger assembly and the hammer have been correctly reassembled into the frame.

	
<h2>WARNING – STORAGE</h2>	
	<p>Never place or store any firearm in such a manner that it may be dislodged. Firearms should always be stored securely and unloaded, away from children and careless adults. Use the locking device originally supplied with this firearm for storage.</p>
	<p>The use of a locking device or safety lock is only one aspect of responsible firearms storage. For increased safety, firearms should be stored unloaded and locked in a location that is both separate from their ammunition and inaccessible to children and any other unauthorized person.</p>
STORE SECURELY & UNLOADED	

To reassemble the revolver for firing, carefully reinsert the trigger housing into the frame. Place the hammer into the top of the frame, and reinsert the hammer pivot pin. Cock the hammer, reinstall the mainspring strut, and remove the

disassembly pin from the mainspring strut. Lower the hammer and replace the grips on the revolver. The revolver is now reassembled and can be loaded and fired normally.

While the revolver is less likely to be used by unauthorized persons when disassembled in the above manner, it is always safest to store a firearm with the supplied locking device correctly installed, or to store the firearm in a gun safe or other secure location, away from children and unauthorized adults. Guns should always be stored securely, unloaded and separate from their ammunition.

CARE OF STAINLESS STEEL REVOLVERS

Revolvers made of stainless steel are more resistant to corrosion than blued steel revolvers. However, in the interest of proper operation and long life of your revolver, inspect it frequently and clean, lubricate and apply an appropriate rust preventative.

Sometimes surface discoloration may be noted, particularly in the grip area of stainless steel revolvers, resulting from perspiration. Contact with some types of holsters can also cause stains or rusting. Rusting may also occur as a result of the revolver being exposed to moisture, humidity, salt air or chemicals.

Minor discoloration can usually be removed by rubbing the stained area with an abrasive ink eraser, crocus cloth, or a "metal polishing" compound. When using any of these abrasives, proceed with care and use light pressure to achieve a blending of 'color' with those areas that are not discolored.

External surfaces of the barrel, frame and cylinder should be cleaned and wiped dry after use or after exposure to adverse conditions. If the revolver is to be stored, coat it with a light film of oil or preservative. Where the revolver is in continuing use, and the presence of oil or grease would be objectionable, then the external surfaces can be coated (after cleaning and drying) with a paste wax formulated for use on metals. Apply the wax sparingly, allow time for it to dry hard, then buff lightly with a soft cloth. When applying the wax, take care that it does not get into the mechanism or on the functioning parts such as the hammer, trigger, crane latch, etc. A properly applied hard wax coating will not interfere with gun handling and it will provide a measure of protection.

ATTACHING RUGER SCOPE RINGS

Each Ruger scope ring is a mated assembly of a top and a base. Do not mix the parts of the two ring assemblies as they are not interchangeable. On the underside of each mounting ring assembly there is an integral lug, located off center with respect to the front and back sides of the mount. The lug is nearer to the front surface. By reference to the lug, the mounting ring can be correctly assembled with the front of the ring toward the muzzle of the revolver.

1. Disassemble one ring and reassemble over the scope body between the turret and the eyepiece. (Note: High ring goes on front mount. Low ring on rear mount.)
2. Install the four top screws. Do not tighten.

3. Disassemble the other ring and install it on the forward section of the scope tube with the lug forwardly also. Install the four top screws. Again, do not tighten.
4. Assemble the rings to the frame with the lugs engaging the recesses in the top surface of the receiver. Tighten the clamp nuts so that the rings are locked to the semi-circular cuts on the sides of the frame.
5. Rotate the scope until cross-hairs are aligned properly, and slide the scope to desired eye relief. Then tighten the eight top screws each a bit at a time to grip the scope body.
6. Sight in according to the directions with your scope.

SIGHTS

The Super Redhawk revolver is provided with an insert front sight. To change the front sight, depress the spring-loaded plunger in the front of the barrel rib with a small punch and lift rear of sight blade. The adjustable rear sight has a white outline blade. Each click of the rear sight adjustment screws (either windage or elevation) will move the point of impact of the bullet approximately 3/4" at a distance of 25 yards. Move the rear sight in the direction you desire the bullet to move on the target. The suggested sight picture is shown below. See "Attaching Ruger Scope Rings," p. 17.

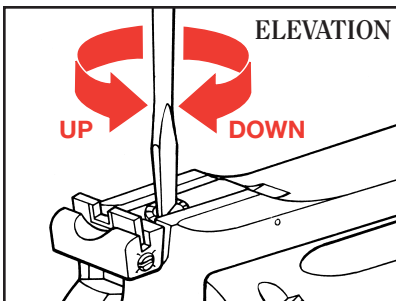

To raise point of impact: turn screw counterclockwise.

To lower point of impact: turn screw clockwise.

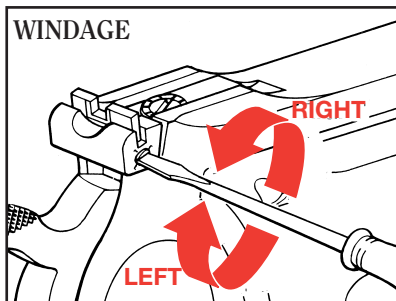

To move the point of impact to the right: turn screw counterclockwise.

To move the point of impact to the left: turn screw clockwise.

SUGGESTED SIGHT PICTURE

- Top of front sight even with top of rear sight blade.
- Front sight centered in notch of rear sight blade. Target bullseye centered on top of front sight.

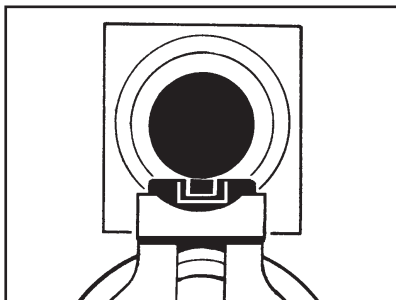

SERVICE AND PARTS POLICY

If you have any questions with regard to the performance of your **RUGER® SUPER REDHAWK** revolver please write or call (603-865-2442) our Product Service Department in Newport, New Hampshire 03773, fully describing all circumstances and conditions involved. If you should return your rifle to the factory for repair, or order parts for it, please comply with the following suggestions for prompt service:



WARNING—BEFORE SHIPPING ANY FIREARM, BE ABSOLUTELY CERTAIN THAT IT AND ITS CYLINDER ARE UNLOADED. DO NOT SHIP CARTRIDGES WITH A FIREARM.

SHIPPING FIREARMS FOR REPAIR

RUGER® SUPER REDHAWK revolvers returned to the factory for repair should be sent to: Sturm, Ruger & Company, Inc., Product Service Department, 411 Sunapee St., Newport, New Hampshire 03773. Telephone (603) 865-2442.

Guns should be sent prepaid. We will not accept collect shipments.

The Federal Gun Control Act, as well as the laws of most States and localities, do not prohibit an individual (who is not otherwise barred from purchasing or possessing a firearm) from shipping a firearm directly to the manufacturer for repair. However, before you ship your revolver to us, be certain that your State or locality does not have a law or regulation which will prohibit you from receiving the revolver from us after it has been repaired. If such receiving is prohibited, then please have a Federally Licensed firearms dealer ship the gun to us. If your revolver is sent to us by a dealer, it will be returned to him after being repaired. If a handgun (pistol or revolver) is shipped by an individual who does not hold a Federal Firearms License, it must be shipped via U.P.S. (Next Day Air) Persons who do not hold a Federal Firearms License are prohibited by Federal law from shipping a handgun by Mail. Handguns mailed in violation of the law are impounded by the Post Office.

Enclose a letter which includes your name, address, telephone number, and serial number and model of the firearm. Describe the trouble you have experienced with your revolver, or the work you wish to have done. Merely saying that the revolver “needs repair” is inadequate information. State precisely what is wrong. Please enclose copies of any previous correspondence.

Work performed will bear a net minimum labor charge of \$20.00 plus a \$20.00 shipping and handling charge. The charge for metal refinishing is \$50.00 plus a \$20.00 shipping and handling charge. Custom gunsmithing service or nonstandard alterations are NOT AVAILABLE from Ruger Product Service Departments.

Please do not send your holster, custom grip panels, or others accessories with any revolver being shipped to us. **DO NOT SEND GUN BOXES OR LITERATURE THAT YOU CONSIDER TO BE COLLECTOR'S ITEMS – THESE ARE INVARIABLY DAMAGED OR DESTROYED IN SHIPMENT.**



WARNING – PARTS PURCHASERS



It is the purchaser's responsibility to be absolutely certain that any parts ordered from the factory are correctly fitted and installed. Firearms are complicated mechanisms and **IMPROPER FITTING OF PARTS MAY RESULT IN A DANGEROUS MALFUNCTION, DAMAGE TO THE FIREARM, AND SERIOUS INJURY TO THE SHOOTER AND OTHER PERSONS.** The purchaser and installer of parts must accept full responsibility for the correct adjustment and functioning of the revolver after such installation.

PARTS MUST FIT CORRECTLY

ORDERING PARTS

Please contact the New Hampshire Product Service Department for parts availability and current prices. All parts orders for the **RUGER® SUPER REDHAWK** revolvers should be sent to : Sturm, Ruger & Co., Inc., Product Service Department, 411 Sunapee Street, Newport, New Hampshire, 03773, 603-865-2442. We cannot comply with open account or C.O.D. orders. Payment in the form of a check, money order, Visa or Mastercard must accompany your order. Credit Card orders must include the account number, expiration date and whether it is a Visa or Mastercard account. Minimum parts order is \$1.00 plus \$3.50 shipping and handling charge. Order parts by Part Name and Part Number and include the entire serial number of the firearm for which the parts are being ordered. There is a minimum net labor charge of \$20.00 plus \$20.00 shipping and handling charge if the parts are factory fitted. All factory fitted parts are fit on an exchange basis only. We will not return the replaced parts.

Barrels, cylinders, cylinder/crane assemblies and a number of other component parts must be fitted at the factory. Company policy is to proof-test and/or function fire all barrels after fitting to the receivers in which they are to be used. This procedure ensures maximum protection to our customers. The special proof-test ammunition used in this testing is sold only to bonafide firearms manufacturers and is not available to gun shops, gunsmiths, or individuals.

Because it is a serial numbered part, the frame of the **RUGER® SUPER REDHAWK** revolver is defined as a 'firearm' by Federal Law and is not offered for sale as a component part.

Parts designated by an asterisk (*) must be factory fitted. These parts are fitted on an exchange basis only. We will not return the replaced parts. We will not return any part that is broken, malfunctioning, badly worn or has been modified. See "Warning – Parts Purchasers" above.



CAUTION: A gun containing modified, broken, malfunctioning, or badly worn parts should not be fired.

RUGER® SUPER REDHAWK

PARTS LIST

Design, prices and specifications subject to change without notice.

SPECIFY MODEL AND CALIBER WHEN ORDERING

(See Exploded View on Page 25.)

Part Name	Part No.	Model
* Barrel, 7 1/2"	KY00610	Super Redhawk - .44 Magnum
* Barrel, 9 1/2"	KY00611	Super Redhawk - .44 Magnum
* Barrel, 7 1/2"	KY00604	Super Redhawk - .454 Casull
* Barrel, 9 1/2"	KY00612	Super Redhawk - .454 Casull
* Barrel, 7 1/2"	KY00607	Super Redhawk - .480 Ruger
* Barrel, 9 1/2"	KY00608	Super Redhawk - .480 Ruger
Cable Lock, 10", Not Illustrated	PM120A	All Super Redhawk Models
Case Only	RGC-L	Super Redhawk - 7 1/2" barrel
Case Only	RGC-XL	Super Redhawk - 9 1/2" barrel
Center Pin	KE-53	All Super Redhawk Models
Center Pin Rod	KH05400	All Super Redhawk Models
Center Pin Spring	KE-34	All Super Redhawk Models
* Crane & Crane Pivot Assembly	KH00800B	All Super Redhawk Models
* Crane Latch Assembly	KY00900A	.44 Magnum Models
* Crane Latch Assembly, Tumble Gray	KY00900TGA	.454 Casull & .480 Ruger Models
* Crane Latch Pivot	KH02700	All Super Redhawk Models
Crane Latch Plunger	KH05100	All Super Redhawk Models
Crane Latch Spring	KE-57	All Super Redhawk Models
* Crane Pivot Lock Plunger	KH06700	All Super Redhawk Models
* Crane Pivot Lock Spring	KH07600	All Super Redhawk Models
* Cylinder Assembly	KH00100D	.44 Magnum Models
* Cylinder Assembly, Non-fluted	KY00105D	.454 Casull Models

Part Name	Part No.	Model
Cylinder Assembly, Non-fluted	KY00107D	.480 Ruger Models
Cylinder Latch	KH04504	All Super Redhawk Models
Cylinder Latch Pivot	KH01400	All Super Redhawk Models
Cylinder Latch Plunger	KE-51	All Super Redhawk Models
Cylinder Latch Spring	KH05000	.44 Magnum Models
Cylinder Latch Spring	KY05000	.454 Casull & .480 Ruger Models
* Cylinder Retaining Ball, (2 Req'd.)	KE03000	All Super Redhawk Models
Disassembly Pin	E-63	All Super Redhawk Models
* Ejector	KH01800	.44 Magnum Models
* Ejector	KY01801	.454 Casull Models
* Ejector	KY01803	.480 Ruger Models
* Ejector Alignment Pins, (2 Req'd.)	KE-35	All Super Redhawk Models
* Ejector Retainer	KH02400	All Super Redhawk Models
Ejector Rod	KH02300	.44 Magnum Models
Ejector Rod, Tumble Gray	KH02300TG	.454 Casull & .480 Ruger Models
Ejector Spring	KE-25	All Super Redhawk Models
* Firing Pin	KH02100	.44 Magnum & .454 Casull Models
* Firing Pin	KY02100	.480 Ruger Models
Firing Pin Rebound Spring	KE-48	All Super Redhawk Models
Front Latch	KH03100	All Super Redhawk Models
Front Latch Pivot Lock	KH07500	All Super Redhawk Models
Front Latch Pivot Lock Spring	KH07700	All Super Redhawk Models
Front Latch Pivot Pin	KH05600	.44 Magnum Models
Front Latch Pivot Pin, Tumble Gray	KH05600TG	.454 Casull & .480 Ruger Models
Front Latch Spring	KE-57	All Super Redhawk Models
Front Latch Spring Plunger	KH06800	All Super Redhawk Models
Front Sight Base	KY03601	All Super Redhawk Models
Front Sight Blade, with Red Insert	Y03606	.44 Magnum Models
Front Sight	Y03605	.454 Casull Models & .480 Ruger with 9 1/2" bbl.

Not Offered For Sale

Part Name	Part No.	Model
Front Sight	Y03608	.480 Ruger with 7 1/2" bbl.
Front Sight Plunger	KH07900	All Super Redhawk Models
Front Sight Plunger Spring	KH08000	All Super Redhawk Models
Grip Panel Ferrule, (Right)	T01101	All Super Redhawk Models
Grip Panel Ferrule, (Left)	T01201	All Super Redhawk Models
Grip Panel Inserts, Wood (Sold in Pairs Only)	T21007	.44 Magnum Models
Grip Panel Inserts, Wood (Sold in Pairs Only)	Y21007	.454 Casull & .480 Ruger Models
Grip Panel Locator	T03301	All Super Redhawk Models
Grip Panel Screw	KE-13	All Super Redhawk Models
Grip, 1 Piece Rubber, No Inserts	T01014	All Super Redhawk Models
Grip, 1 Piece Rubber with Wood Inserts	T21000-CS	.44 Magnum Models
Grip, 1 Piece Rubber with Wood Inserts	Y21000-CS	.454 Casull & .480 Ruger Models
* Hammer Assembly	KY04000B	.44 Magnum Models
* Hammer Assembly, Tumble Gray	KY04000TGB	.454 Casull & .480 Ruger Models
* Hammer Dog	KH01900	All Super Redhawk Models
Hammer Dog Pivot Pin	KE-22	All Super Redhawk Models
Hammer Dog Plunger	KH05100	All Super Redhawk Models
Hammer Dog Spring	KE-57	All Super Redhawk Models
Hammer Pivot Assembly	KE-16B	.44 Magnum Models
Hammer Pivot Assembly, Tumble Gray	KE-16TGB	.454 Casull & .480 Ruger Models
Hammer Strut	KT01500	All Super Redhawk Models
Hammer Strut Mainspring	KW00401	.44 Magnum Models
Hammer Strut Mainspring	KY00400	.454 Casull & .480 Ruger Models
Hammer Strut Seat	KT00500	All Super Redhawk Models
Pawl	KH00700	All Super Redhawk Models
Pawl Plunger	KH05100	All Super Redhawk Models
Pawl Plunger Spring	KH05000	All Super Redhawk Models
Rear Sight Assembly, High, Complete	H05900C	.44 Magnum Models
Rear Sight Assembly, Low, Complete	H05900D	.454 Casull & .480 Ruger Models

Part Name	Part No.	Model
Rear Sight Base Assembly	MR15900C	All Super Redhawk Models
Rear Sight Blade, High, White Outline Notch	H07203A	.44 Magnum Models
Rear Sight Blade, Low, White Outline Notch	E05904A-A	.454 Casull & .480 Ruger Models
Rear Sight Pivot Pin	KMR05600	All Super Redhawk Models
Rear Sight Elevation Screw	MR05902	All Super Redhawk Models
Rear Sight Elevation Spring, (2 Req'd.)	MR05906	All Super Redhawk Models
Rear Sight Windage Adjustment Screw	E05903	All Super Redhawk Models
Rear Sight Windage Spring	MR05907	All Super Redhawk Models
* Recoil Plate	KMR02000	All Super Redhawk Models
Recoil Plate Cross Pin	KH04900	All Super Redhawk Models
Scope Ring Assembly, Low Rings	KD71L	.44 Magnum Models
Scope Ring Assembly, Low Rings, Tumble Gray	KD71LTG	.454 Casull & .480 Ruger Models
Scope Ring Clamp, Not Illustrated	D-74	All Super Redhawk Models
Scope Ring Nut	D-73	All Super Redhawk Models
Scope Ring Screw, Set of 8	D-76	All Super Redhawk Models
Transfer Bar	KH01700	All Super Redhawk Models
* Trigger Assembly	KT03900B	.44 Magnum Models
* Trigger Assembly, Tumble Gray	KT03900TGB	.454 Casull & .480 Ruger Models
* Trigger Guard	KT00300A	All Super Redhawk Models
Trigger Guard Latch	KT04600	All Super Redhawk Models
Trigger Guard Latch Pin	KE-22	All Super Redhawk Models
Trigger Guard Latch Spring	KT03800	.44 Magnum Models
Trigger Guard Latch Spring	KY03801	.454 Casull & .480 Ruger Models
Trigger Link	KT07100	All Super Redhawk Models
Trigger Link Pin	KH06400	All Super Redhawk Models
Trigger Link Plunger	KT03700	All Super Redhawk Models
Trigger Pivot Pin	KE02800	All Super Redhawk Models
Trigger Plunger	KH03200	All Super Redhawk Models

* **PARTS SO MARKED MUST BE FACTORY FITTED**

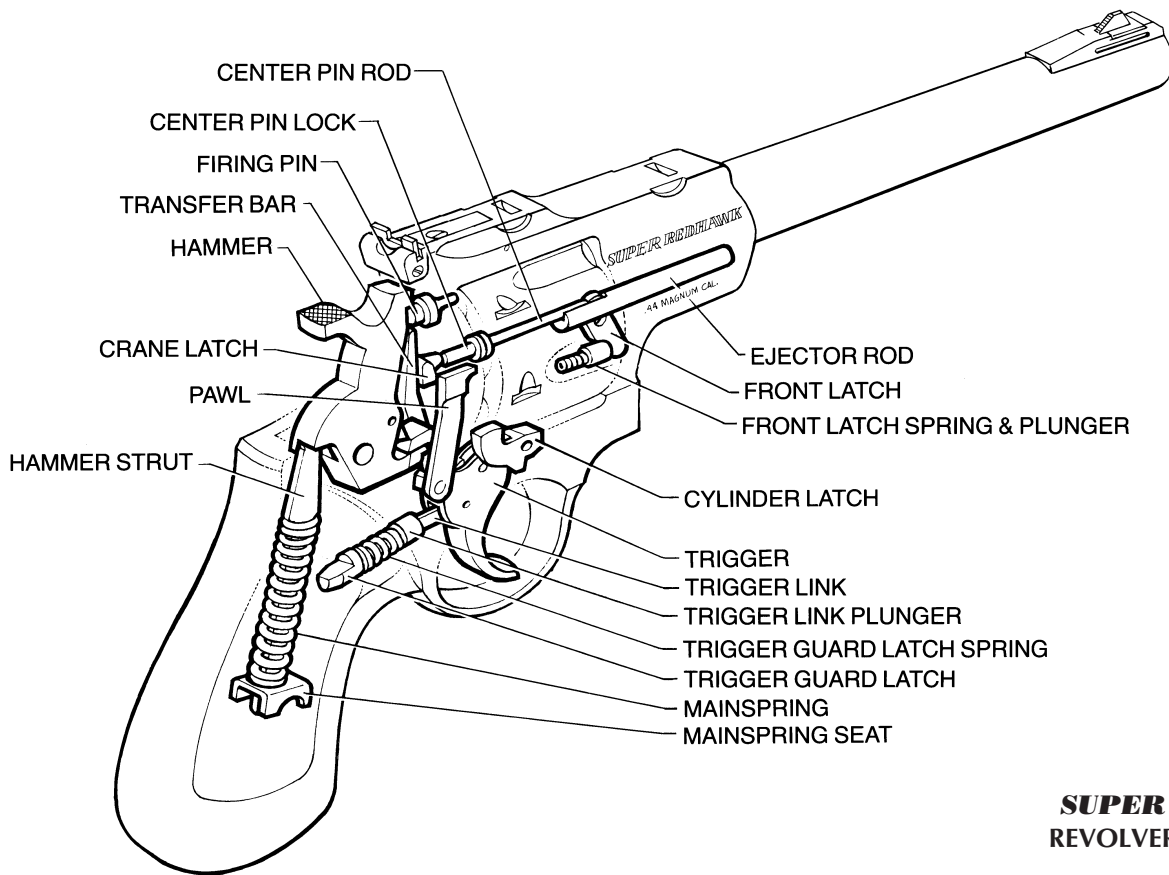

SUPER REDHAWK
REVOLVER MECHANISM

THE BASIC RULES OF SAFE FIREARMS HANDLING

We believe that Americans have a right to purchase and use firearms for lawful purposes. The private ownership of firearms in America is traditional, but that ownership imposes the responsibility on the gun owner to use his firearms in a way which will ensure his own safety and that of others. When firearms are used in a safe and responsible manner, they are a great source of pleasure and satisfaction, and represent a fundamental part of our personal liberty.

Firearms do not cause accidents! Firearms accidents are almost always found to have been the result of carelessness, or ignorance on the part of the shooter of the basic rules of safe gun handling.

The following rules must be observed by gun users at all times. Safe gun handling is not just desirable, it is absolutely essential to your safety, the safety of others, and the continuation of gun ownership and sport shooting as we know it today.

1. LEARN THE MECHANICAL AND HANDLING CHARACTERISTICS OF THE FIREARM YOU ARE USING.

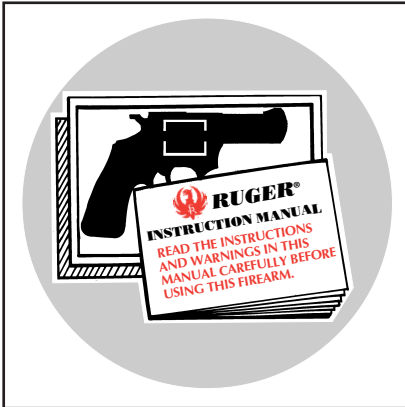

Not all firearms are the same. The method of carrying and handling firearms varies in accordance with the mechanical provisions for avoiding accidental discharge and the various proper procedures for loading and unloading. No person should handle any firearm without first having thoroughly familiarized himself with the particular type of firearm he is using, and with safe gun handling in general.

2. ALWAYS KEEP THE MUZZLE POINTED IN A SAFE DIRECTION.



Be sure of the bullet stop behind your target, even when dry-firing. Never let the muzzle of a firearm point at any part of your body or at another person. This is particularly important when loading or unloading a firearm. In the event of an accidental discharge, no injury can occur as long as the muzzle is pointing in a safe direction. A safe direction means a direction which

will not permit a discharged bullet to strike a person, or to strike an object from which the bullet may ricochet.

A safe direction must take into account the fact that a bullet may penetrate a wall, ceiling, floor, window, etc., and strike a person or damage property. Make it a habit to know exactly where the muzzle of your gun is pointing whenever you handle it, and be sure that you are always in control of the direction in which the muzzle is pointing, even if you fall or stumble. Keep your finger off the trigger until you are ready to shoot.

3. FIREARMS SHOULD BE UNLOADED WHEN NOT IN USE.

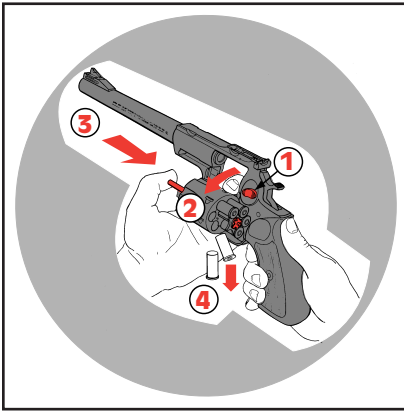

Firearms should be loaded only when you are in the field or on the target range or shooting area, ready to shoot. Firearms and ammunition should be securely locked in safes, racks or cabinets, or by using the locking device supplied with the firearm, when not in use. Ammunition should safely be stored separate from firearms. Store your firearms out of sight of visitors and children. It is the gun owner's responsibility to be certain that children and

persons unfamiliar with firearms cannot gain access to firearms, ammunition, or components.

4. BE SURE THE BARREL IS CLEAR OF OBSTRUCTIONS BEFORE SHOOTING.

Even a bit of mud, snow or excess lubricating oil or grease in the bore may cause the barrel to bulge, or even burst on firing, and can cause serious injury to the shooter and bystanders. Be sure that you are using ammunition of the proper caliber and loading for the gun you are using. If the report or recoil on firing seems weak, or doesn't seem quite right, **CEASE FIRING IMMEDIATELY**, unload your firearm, and check to be sure that no obstruction has become lodged in the barrel.





5. BE SURE OF YOUR TARGET BEFORE YOU SHOOT.

Don't shoot unless you know exactly where your bullet is going to strike. Be sure of the bullet stop behind your target, even when dry-firing with an unloaded gun. If you are in the field hunting, do not fire at a movement or noise. Take the time to be absolutely certain of your target before you pull the trigger.

6. WEAR SHOOTING GLASSES AND HEARING PROTECTORS WHEN YOU SHOOT.

All shooters should wear protective shooting glasses and adequate hearing protectors when shooting. Exposure to shooting noise can damage hearing, and adequate eye protection when shooting is essential.



7. NEVER CLIMB A TREE OR FENCE WITH A LOADED FIREARM.

Put the firearm down carefully before climbing a fence, and unload it before climbing or descending a tree or jumping over a ditch or other obstruction. Never pull or push a loaded firearm toward yourself or another person. When in doubt, or whenever you are about to do anything awkward, unload your gun!

8. DON'T SHOOT AT A HARD SURFACE, OR AT WATER.

Bullets can glance off many surfaces like rocks or the surface of water and travel in unpredictable directions with considerable velocity.



9. NEVER TRANSPORT A LOADED FIREARM.

Firearms should always be unloaded before being placed in a vehicle. A suitable carrying case or scabbard should be used to carry an unloaded firearm to and from the shooting area.

10. AVOID ALCOHOLIC BEVERAGES WHEN SHOOTING.

Don't drink until the day's shooting is over. Handling firearms while under the influence of alcohol in any form, or medications that could affect your judgment or co-ordination, constitutes a criminal disregard for the safety of others.



A BRIEF ACCOUNT OF AN EXTRAORDINARY ACHIEVEMENT: RUGER FIREARMS

One of the few American firearms manufacturers whose management has remained unchanged since starting in business, Sturm, Ruger & Company, Inc., had its beginning in a small machine shop occupying a rented frame building in Southport, Connecticut. In January, 1949, with an initial investment of only \$50,000 and an idea, William B. Ruger and Alexander M. Sturm started production of a .22 caliber autoloading pistol—a design which was so successful that it became the cornerstone upon which one of the most comprehensive lines of sporting firearms ever made in America was established. After Alex Sturm's death in 1951, William B. Ruger continued to direct the company alone and today, as Chairman Emeritus of the Board, he continues to provide the guidance which has made this 52-year-old company a sound and successful enterprise.

Sturm, Ruger & Company, in this relatively short time, has established itself as a leading small arms design organization, developing a unique and broad line of fine quality sporting, military and police firearms to become one of the world's most famous producers of revolvers, pistols, rifles and shotguns. From 1949 thru 2001 Ruger craftsmen have built many millions of firearms.

During its five decades of growth and progress under the leadership of William B. Ruger, the company has developed a business philosophy and implemented policies which represent a constructive influence in the life of modern America. From the beginning, Sturm, Ruger & Company played a positive role in conservation efforts and has supported the interests of shooters through such groups as the National Rifle Association, National Shooting Sports Foundation, and many regional sportsmen's organizations. The company has always endeavored to market its firearms for constructive and recreational purposes, to emphasize the traditional aspects of shooting, to render meaningful public services and to encourage shooters in constructive, responsible, and safe participation in the shooting sports.

Today, Sturm, Ruger & Company is particularly mindful of those elements which have contributed to the creation of its success, and extends heartfelt thanks to its many loyal employees and customers.

A current catalog of Ruger firearms is available free upon request to
Sturm, Ruger & Co., Inc., Southport, CT 06490.

WHY NO WARRANTY CARD HAS BEEN PACKED WITH THIS NEW RUGER FIREARM

The Magnuson-Moss Act (Public Law 93-637) does not require any seller or manufacturer of a consumer product to give a written warranty. It does provide that if a written warranty is given, it must be designated as "limited" or as "full" and sets minimum standards for a "full" warranty. Sturm, Ruger & Company, Inc. has elected not to provide any written warranty, either "limited" or "full", rather than to attempt to comply with the provisions of the Magnuson-Moss Act and the regulations issued thereunder. There are certain implied warranties under state law with respect to sales of consumer goods. As the extent and interpretation of these implied warranties varies from state to state, you should refer to your state statutes. Sturm, Ruger & Company wishes to assure its customers of its continued interest in providing service to owners of Ruger firearms.



STURM, RUGER & Company, Inc.
Southport, Connecticut 06490 U.S.A.
<http://www.ruger-firearms.com>

“Arms Makers For Responsible Citizens”

**A COPY OF THE INSTRUCTION MANUAL FOR ANY RUGER
FIREARM IS AVAILABLE FROM THE FACTORY FREE ON REQUEST.
THESE INSTRUCTION MANUALS CONTAIN IMPORTANT
WARNINGS WHICH MUST BE UNDERSTOOD
BEFORE USING THESE FIREARMS.**

“RUGER”, the Sturm, Ruger logo, “SINGLE-SIX”, “BLACKHAWK”, “REDHAWK”, “SECURITY-SIX”,
“SPEED-SIX”, “SERVICE-SIX”, “BEARCAT”, “OLD ARMY”, “10/22”, “MINI-14”, “MINI THIRTY”,
“RANCH RIFLE”, “M77”, “77/22”, “GP-100”, “SP101”, “P-85” and “VAQUERO”
are registered U.S. trademarks.
“77/50” is a Ruger trademark.