

INSTRUCTION MANUAL FOR

BLUED
STEEL



CALIBER
.44 Rem. Magnum

RUGER® **DEERFIELD® CARBINE** AUTOLOADING RIFLE



**READ THE INSTRUCTIONS AND
WARNINGS IN THIS MANUAL CAREFULLY
BEFORE USING THIS FIREARM**

**For Product Service on This Model Please Call:
(603) 865-2442 (See p. 28)**

**STURM, RUGER & Company, Inc.
Southport, Connecticut 06490 U.S.A.**

THIS INSTRUCTION MANUAL SHOULD ALWAYS ACCOMPANY THIS FIREARM AND BE
TRANSFERRED WITH IT UPON CHANGE OF OWNERSHIP, OR WHEN THE FIREARM IS LOANED OR
PRESENTED TO ANOTHER PERSON.



WARNING – LOCKING DEVICES

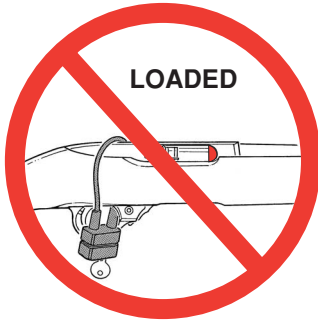

**DO NOT INSTALL
INSIDE TRIGGER GUARD**

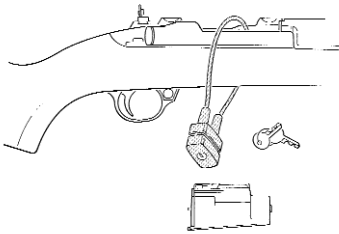

**INSTALL LOCK
AS SHOWN HERE**

This firearm was originally sold with a key-operated locking device. While it can help provide secure storage for your **unloaded** firearm, any locking device can fail. All guns are designed to fire if they are loaded and the trigger is pulled. Therefore, **never install the locking device inside the trigger guard or in any way that it can possibly pull the trigger!** Do not leave the keys in the lock.

The ultimate responsibility for secure storage of any firearm must depend upon its owner and his or her individual circumstances.

Guns should be securely stored unloaded, in a secure location, separate from their ammunition.

See “Storage Warning”, page 25.

**NEVER INSTALL
LOCKING DEVICE
INSIDE TRIGGER GUARD**

FIREARMS SAFETY-YOUR RESPONSIBILITY

SAFETY MUST BE THE FIRST AND CONSTANT CONSIDERATION OF EVERY PERSON WHO HANDLES FIREARMS AND AMMUNITION.

This Instruction Manual is designed to assist you in learning how to use and care for your **RUGER® DEERFIELD® CARBINE** properly. Please contact us if you have any questions about it.

Only when you are certain you fully understand the Manual and can properly carry out its instructions should you practice loading, etc. with live ammunition. If you have any doubts about your ability to handle or use a particular type of gun safely, then you should seek supervised instruction. Such personalized instruction is often available from gun dealers, gun clubs or police departments. If none of these sources can help you, write to the National Rifle Association, 11250 Waples Mill Road, Fairfax, VA 22030-7400. They will assist you.

The person possessing a gun has a full-time job. You cannot guess; you cannot forget. You must know how to use your firearm safely. **Do not use any firearm without having a complete understanding of its particular characteristics and safe use.**

Remember: There is no such thing as a foolproof gun.

TABLE OF CONTENTS

	Page
General Information5
Operation of Safety6
The Bolt Lock	8
Ammunition	9
To Load and Fire (With Magazine)	11
To Load and Fire (Without Magazine)	13
To Unload	14
To Extract and Eject a Chambered Cartridge	15
To Clear a Malfunction ("Jam")	15
To Minimize Malfunctions ("Jams")	16
Disassembly	18
Reassembly	21
Magazine Inspection and Care	22
Care and Cleaning	23
Storage	24
Attaching Ruger Scope Rings	26
Sight Adjustment	26
Service and Parts Policy	28
Parts Drawing	33
The Basic Rules of Safe Firearms Handling	34
Warranty Information	40

"RUGER" and "Deerfield" are registered U.S. trademarks.

"Deerfield" is a registered trademark of Blount, Inc.



WARNINGS OF GREAT IMPORTANCE ARE FOUND ON THE FOLLOWING PAGES:

Locking Devices	3	Unloading	13
Alterations	5	Malfunctions	17
Manual Safety	7	Disassembly	17
Ammunition	9	Lubrication	24
Lead Exposure	10	Storage	25
Firing	12	Parts Purchasers	29
Handling	13		

OTHER CAUTIONS AND WARNINGS APPEAR THROUGHOUT THE MANUAL.

**FIREARMS ARE DANGEROUS WEAPONS—
READ THE INSTRUCTIONS AND WARNINGS
IN THIS MANUAL THOROUGHLY AND
CAREFULLY BEFORE USING.**



WARNING—ALTERATIONS



This product was designed to function properly in its original condition. Alterations can make it unsafe. Do not alter any part or add or substitute parts or accessories not made by Sturm, Ruger & Co. Inc.

DO NOT ALTER ANY GUN

GENERAL INFORMATION AND MECHANICAL CHARACTERISTICS

The **RUGER® DEERFIELD® CARBINE** is a gas operated, rotary magazine fed, autoloading rifle. It is simple, reliable, and consists of a relatively few rugged components. The mechanism employs the Ruger fixed piston/moving cylinder gas system in conjunction with a simplified rotating bolt.

Music wire coil springs are used throughout the mechanism. The **RUGER® DEERFIELD® CARBINE** has a cross-button safety which is located in the forward portion of the trigger guard. The safety blocks the trigger and sear while permitting the slide to be cycled with the safety "ON". A bolt lock mechanism is provided for convenience in holding the bolt open for loading and inspection. The firing pin is retracted mechanically as the bolt starts to unlock and the rifle will fire only when the bolt is locked. The one-piece stock is American hardwood.

The **RUGER® DEERFIELD® CARBINE** has an internal buffer system that effectively absorbs the shock of the slide block striking the receiver in recoil. The bolt lock plunger is located at the rear of the slide handle, and when depressed, fits into a slot in the receiver holding the bolt open. The ejector is an integral part of the receiver and ejects the empty cartridges out to the side.

The patented Ruger integral scope mounts take all standard Ruger scope rings of various heights. A standard bead type front sight is used, with a flip-up type folding rear peep sight, adjustable for windage and elevation.

NOMENCLATURE

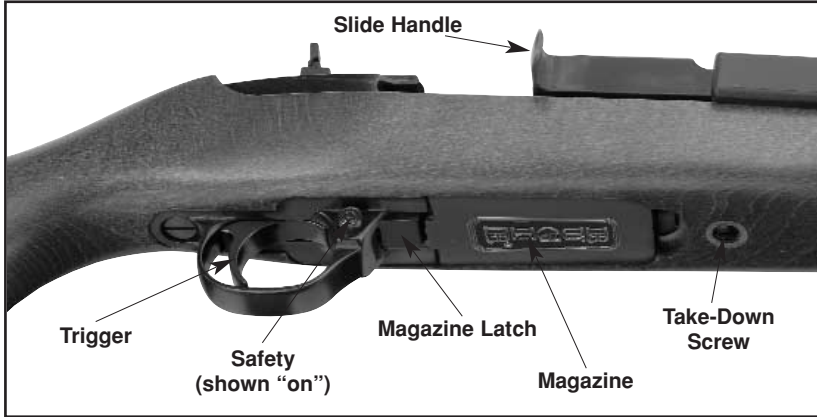
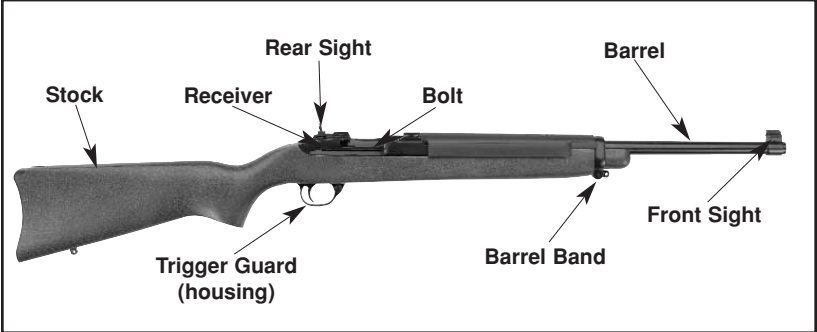

Figure 1. In this illustration the frequently used operating components are identified. Note that the safety is protruding fully from the right side of the trigger guard and is therefore in its "ON" (safe) position.

OPERATION OF SAFETY

The **RUGER® DEERFIELD® CARBINE** has a cross-button safety which is located in the forward portion of the trigger guard (Figure 1). The safety can be operated once the internal hammer is cocked by retracting the slide.

The safety is “on” when it protrudes fully from the right side (the slide handle side) of the trigger guard assembly, as shown in Figure 1. In this position the trigger and sear are blocked, and the gun cannot be fired from a normal pull on the trigger. **The safety should always be in the “on” (safe) position except when the shooter is actually firing the gun. The safety should be moved to the “on” position whenever the shooter ceases firing, even temporarily.**

The safety is “off” (fire) when it protrudes from the left side of the trigger guard assembly, as shown in Figure 2. When the safety is off, the red band shows on the safety button, but do not totally rely on the appearance of the red band to indicate that the safety is off. In poor light or if dirt is present, the red band may not be visible. **If the safety is “off” and the trigger is pulled, the rifle will fire.**

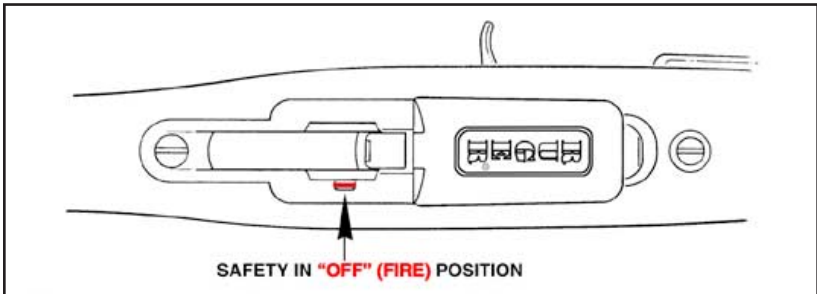

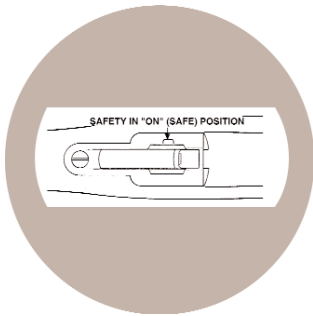

Figure 2. The underside of the trigger guard section of the rifle. In this illustration the safety is shown in the “off” (fire) position. The position of the safety and red band indicate the safety is “off.” **It should be in this position only when you are actually firing at a target.**

The safety is held in its “on” or “off” position by a plunger that is under spring tension. When the safety is moved to either the “on” or “off” position, a distinct “click” should be heard. Frequently check the position of the safety to be certain the safety has not been inadvertently moved. If the safety seems to move too easily, or if the click is not heard when the safety is moved, stop using the rifle and return it to the Newport Product Service Department for repair (see p. 28).

	WARNING – MANUAL SAFETY
	Keep the safety on unless actually firing. Always move the safety fully to its intended position and check it. The safety is not “ON” unless it is completely “ON”. Never depend on a safety mechanism or any other mechanical device to justify careless handling or permitting the rifle to point in an unsafe direction. The only “safe” rifle is one in which the bolt is open, the chamber is empty, and there is no magazine in the gun.
KNOW HOW TO USE THE SAFETY	

THE BOLT LOCK

The bolt lock is located in the rear of the slide handle (see Figure 1, p. 6). The bolt lock is the manually operated means of retaining the bolt in the rearward (open) position. When the bolt is locked open, the rifle is in an inoperative safe condition for inspection of the chamber, cleaning, etc.

WARNING: The bolt lock is *not* a safety device. It should not be used to hold the bolt back when there is a loaded magazine in the rifle. A slight jar to the butt end of the rifle will cause the bolt lock to disengage and to feed a cartridge into the chamber.

The bolt lock should be relied on only to hold the bolt in its rearward position when the chamber is empty and an empty magazine is in place. The only purpose of the bolt lock is for convenience in changing magazines and for holding the bolt in its rearward position when the rifle is unloaded for the purpose of cleaning or inspection.

OPERATION OF BOLT LOCK

To manually engage the bolt lock to keep the bolt open: (See Figure 3)

1. Pull the slide handle all the way to the rear.
2. Depress the bolt lock plunger and allow the slide to move forward slightly until it stops.
3. Put safety "ON" (push fully to the right).

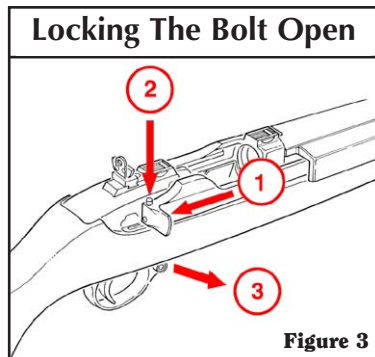

To release the slide (which allows the bolt to go forward) keep safety "ON" and draw the slide handle to the rear and release. Do not "ride" the slide handle forward with your fingers, as this may result in misfeeding of cartridges (see "To Minimize Malfunctions", p. 16)

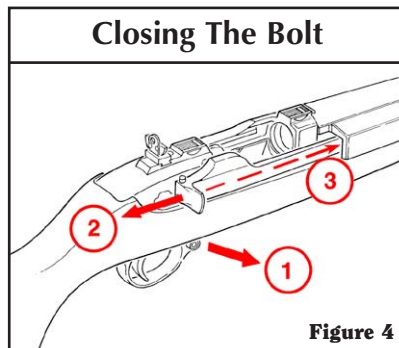

CAUTION: Slide is under heavy spring tension and can injure fingers when it slams shut. Keep fingers away from chamber and trigger.



AMMUNITION

The **RUGER® DEERFIELD® CARBINE** relies upon the gases produced from the fired cartridge to cycle the action and is chambered **only** for the .44 Magnum cartridge. It should not be used with any other .44 caliber ammunition, such as the .44 Special. Most .44 Magnum ammunition factory loaded to U.S. industry specifications is suitable for use. However, “Medium Velocity” non-jacketed ammunition may not produce the volume of gas necessary to consistently cycle the action or give optimum accuracy and is not recommended. Do not use lead bullets -- they will clog the gas port in the barrel and prevent proper action cycling. Aluminum-cased ammunition should not be used, as it may stick in the chamber when fired, resulting in extraction and functioning problems. .44 Magnum cartridges with bullet weights below 215 grains are generally not compatible with the Ruger Deerfield Carbine, and those with bullet weights above 255 grains generally exceed the maximum overall length of 1.610” allowed by U.S. Industry Standards and may not fit into the magazine. Such cartridges at either end of the spectrum of .44 Magnum ammunition loadings should not be used in the Ruger Deerfield Carbine. See “Ammunition Warning” below, & “Ammunition Notice”, p. 10.

USE ONLY CORRECT FACTORY AMMUNITION LOADED TO U.S. INDUSTRY STANDARDS

	WARNING – AMMUNITION	
	<p>Death, serious injury, and damage can result from the use of wrong ammunition, bore obstructions, powder overloads, or incorrect cartridge components. Even the strongest gun can be “blown up” as a result of excess pressure. <u>Always</u> wear shooting glasses and hearing protectors.</p>	IMPROPER AMMUNITION DESTROYS GUNS
		

AMMUNITION (CARTRIDGES) NOTICE

WE SPECIFICALLY DISCLAIM RESPONSIBILITY FOR ANY DAMAGE OR INJURY WHATSOEVER OCCURRING IN CONNECTION WITH, OR AS THE RESULT OF, THE USE IN RUGER FIREARMS OF FAULTY, OR NON-STANDARD, OR "REMANUFACTURED" OR HAND LOADED (RELOADED) AMMUNITION, OR OF CARTRIDGES OTHER THAN THOSE FOR WHICH THE FIREARM WAS ORIGINALLY CHAMBERED.



WARNING – LEAD EXPOSURE



Discharging firearms in poorly ventilated areas, cleaning firearms, or handling ammunition may result in exposure to lead and other substances known to the state of California to cause birth defects, reproductive harm, and other serious physical injury. Have adequate ventilation at all times. Wash hands thoroughly after exposure.

**SHOOTING OR CLEANING GUNS
MAY EXPOSE YOU TO LEAD**

TO LOAD AND FIRE (WITH MAGAZINE)

Practice this important aspect of gun handling (with an unloaded rifle) until you can perform each of the steps – described below – with skill and confidence. But before you do anything with the rifle, please first read completely through this manual.

1. **Keep the muzzle pointed in a safe direction.** (See Rule 2, p. 34).
2. Pull the slide handle rearward. Engage the bolt lock so that the bolt is held open. Check the chamber to be certain it is empty. **Engage the safety.** (See Figure 1, p. 6).
3. Remove the magazine from the rifle. (See Figure 5, below).



Figure 5. The safety should be in the “Safe” position when the magazine is being removed or inserted. When the forward section of the magazine latch is pushed in (pivoted upward), the magazine is released. One way of removing the magazine is to cradle the rifle in the left hand with the palm under - but not against - the magazine. Use the right forefinger to fully depress the magazine latch and the magazine will drop free. Another way (illustrated) is to depress the latch with the thumb and at the same time grasp the magazine between the thumb and forefinger and draw it out of the gun.

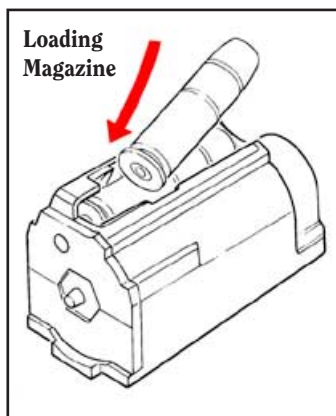

4. Load the magazine by sliding up to four (4) cartridges into the magazine throat-opening as described below. (See Figure 6). The Ruger Deerfield Carbine is designed to function properly only with standard Ruger 4-shot rotary magazines loaded with factory .44 Rem. Mag. cartridges of the correct type. (See “Ammunition”, p. 9)

Figure 6. To load the magazine, press the rim of the cartridge against the magazine rotor at the widest section of the magazine throat until the cartridge enters far enough to be pushed to the rear end of the magazine. Each succeeding cartridge is pressed against the body of the top cartridge and slid to the rear of the magazine until a maximum of four (4) cartridges are in the magazine



NOTE: The .44 magnum magazines for the Ruger 96/44 lever action rifle and the Ruger 77/44 bolt action rifle will **not** fit into the Deerfield Carbine rifle due to dimensional differences. **Do not** attempt to use either of them in the Deerfield Carbine.

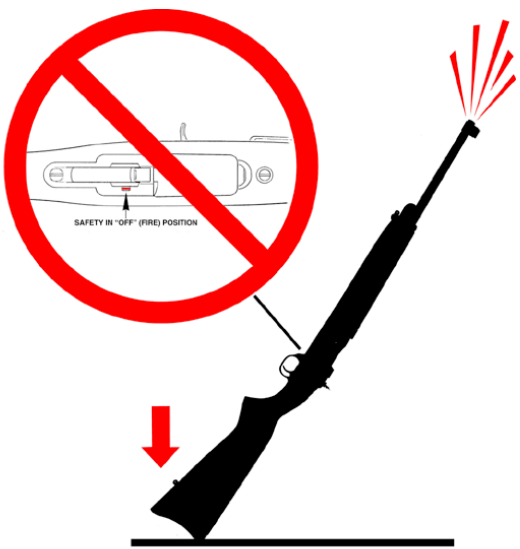

5. Insert magazine into the firearm, with bullet end of the cartridges toward the muzzle. (Magazine cannot be seated if reversed).
6. Load a cartridge into the chamber by fully retracting the slide handle (which will automatically release the bolt lock) and then releasing the handle. **Don't touch the trigger.** Do not 'ride' the slide handle as it moves forward. Do not apply force to the slide handle to chamber a cartridge. If a cartridge does not readily chamber, eject it from the rifle, lock the bolt open, remove the magazine and see MALFUNCTION WARNING, p. 17.
7. The rifle is now fully loaded. **If the rifle is not to be fired immediately, the safety should remain "ON"** (See Figure 1, p. 6). Only when you are ready to fire at a selected target, move the safety to the "off" position. The rifle will fire a single cartridge each time the trigger is pulled and released until all the cartridges in the magazine, and the one in the chamber, have been fired. Firing will automatically reload and recock the rifle. **NOTE THAT EVERY TIME THE TRIGGER IS PULLED, IF A CARTRIDGE IS IN THE CHAMBER, THE RIFLE WILL FIRE – BE CAREFUL!**
8. **Immediately following the firing of a shot, and if a subsequent shot is not to be fired at once, put the safety "ON" while the rifle is still pointing in a safe direction down range.** The safety should be moved to the "on" position as soon as firing is completed, and it should be "on" at all times except when the rifle is on target and being fired.
9. The bolt does not remain open after the last shot has been fired, nor does the bolt automatically lock open when the magazine is empty. When firing is completed, put the safety "ON" and manually retract the bolt, lock it open, and visually check the chamber to be sure it is empty. **If the bolt is shut, the shooter should always assume that there is a cartridge in the chamber. Don't rely on your memory to know if a gun or magazine is loaded. Visually inspect the magazine and the chamber.**

 WARNING – FIRING	
	The bolt automatically opens and shuts quickly while firing. Keep face and hands away from it. Hot brass and powder gas are ejected quickly and can burn you. The rifle should be fired from the right shoulder. Always wear shooting glasses and hearing protectors.
	BOLT OPENS FAST– HOT BRASS EJECTED

 <h2 style="margin: 0;">WARNING – HANDLING</h2>	
	<p>If dropped or struck with the safety “off”, the rifle may fire. Keep chamber empty unless actually firing! Keep safety “on” unless actually firing!</p>
<p>ANY GUN MAY FIRE IF DROPPED</p>	

TO LOAD AND FIRE (WITHOUT MAGAZINE)

The rifle can be used as a single shot rifle in the absence of a magazine or for safety or training purposes. To do so, follow steps 1 and 2, p. 11. Then load a cartridge into the chamber, and follow steps 6 through 9, p. 12, disregarding the magazine. **Engage the safety between shots, and disengage it only when actually firing at a selected target.**

 <h2 style="margin: 0;">WARNING – UNLOADING</h2>	
	<p>So that the rifle can be used as a single loader, it will fire whether or not a magazine is in the gun if a cartridge is chambered. Removing magazine does not unload rifle! To unload, first remove magazine, then pull slide to rear, eject chambered cartridge, and visually inspect chamber. The safety should always be in the “on” (safe) position when loading or unloading the rifle. Keep safety “on”.</p>
<p>GUN WILL FIRE WITH “MAGAZINE” OUT</p>	

TO UNLOAD

NOTE: This sequence must be followed exactly as spelled out. Failure to do so can result in the rifle's chamber becoming unintentionally loaded with a cartridge!

1. Keep the muzzle pointed in a safe direction at all times and keep fingers outside the trigger guard. **Move the safety to the "on" ("safe") position.**
2. Remove the magazine. **Remember that even though the magazine has been removed, a cartridge remaining in the chamber can still be fired!**
3. Retract the bolt to its open position and lock it there. This should eject any cartridge in the chamber, but...
4. **Always visually double check the chamber to be certain it is empty.** The only "safe" rifle is one in which the bolt is open and the chamber and magazine are empty.
5. Cartridges can be removed from the magazine by simply pushing them lightly downward and forward with the thumb, forefinger, or the rubber eraser end of a pencil against the rim of the top cartridge. Do not use a loaded cartridge as a 'tool' to strip cartridges from the magazine.
6. If desired, the slide can be left in the open position, being held there by the slide lock. If it is desired to close the slide, again look to be certain the chamber is empty. Put the safety "on", retract the slide to its rearmost position to release the slide lock and let the slide snap forward. Keep your fingers out of the receiver!

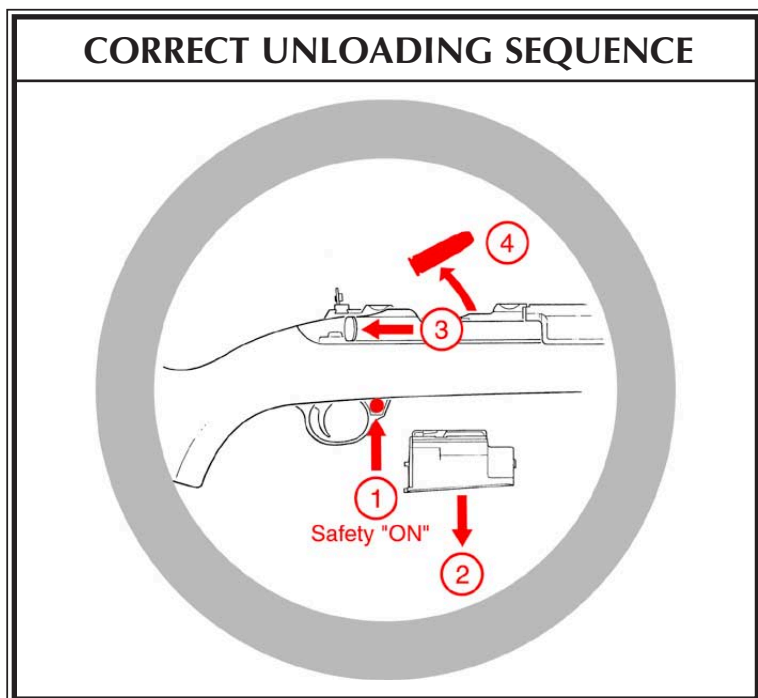

7. **With the muzzle pointed in a safe direction**, push the safety to the “off” position and pull the trigger to decock it. The rifle can be “dry fired” for practice as long as it is empty and pointed in a safe direction.
8. Push empty (unloaded) magazine into the rifle until the catch locks it in place.

TO EXTRACT AND EJECT A CHAMBERED CARTRIDGE

When the rifle is fired, the same gas pressure that drives the bullet forward acts through the gas port to push the slide and bolt to the rear. This action causes extraction and ejection of the fired cartridge case. If a cartridge fails to fire or if the shooter wishes to eject the chambered cartridge manually, follow the procedure “To Unload” step 3, p. 14. When the slide handle is operated there can be a failure to extract the cartridge from the chamber, or a failure to eject the cartridge clear of the rifle. These failures usually are the result of the slide handle not being pulled rearward vigorously. From the foregoing, it is clear that the gun user must:

1. **Always visually check the chamber and the breech-face after opening the slide to eject a chambered cartridge.** If the slide is not vigorously retracted, the extracted cartridge can be “ejected” into the magazine area or remain held to the breech-face by the extractor.
2. **Thoroughly clean the chamber and the extractor as often as necessary.**

If an empty magazine is in the rifle when the slide handle is being retracted to extract a cartridge, the cartridge may drop on top of the magazine or remain held to the breech-face by the extractor. Then, when the slide goes forward, the cartridge will be chambered again! **REMEMBER -- always remove the magazine before clearing the chamber, and visually check to ensure that no cartridges remain in the gun. Keep the safety “on” at all times except when actually firing.**

TO CLEAR A MALFUNCTION (“JAM”)

Any autoloading firearm may occasionally malfunction. If it does:

1. **Be certain the muzzle is pointed in a safe direction and the safety is “on”.**
2. If possible, first remove the magazine. It may be necessary to manually remove a jammed cartridge which has only partially been stripped from the magazine.

If so, use extreme care. Lock the slide open with the slide stop before attempting to clear the jam. Drawing the slide fully to the rear may bring the jammed cartridge along. **Keep your face away from the ejection port during this operation.** When attempting to clear a jam, use only wood ‘tools’ so that a cartridge will not be ignited if you strike a primer, and so that the chamber and magazine will not be damaged. A 3/16” wood dowel rod with a point on one end is useful. Use this tool to carefully remove the jammed cartridge and any foreign materials that may have caused the jam.

3. Visually check to make sure all cartridges have been removed from the rifle. Safely dispose of any cartridges involved in a malfunction incident. Do not use damaged ammunition in any firearm.

TO MINIMIZE MALFUNCTIONS (“JAMS”)

Most malfunctions are caused by improper or damaged magazines, incorrect ammunition, or poor maintenance.

1. If it appears that the gun and magazine are not at fault and that the jam was caused by the type of cartridge being used, then try another type.
2. If changing to another type or brand of cartridges does not at once eliminate malfunctioning, then the following steps should be taken:
 - a. **Make certain the gun and the magazine are unloaded and that the safety is “on”. Remember, the magazine should be removed first, then check the chamber and be certain it and the magazine-well are clear of cartridges.**
 - b. Thoroughly clean the magazine (See “Magazine Inspection and Care”, p. 22) and bolt mechanism, paying particular attention to removing accumulated grease. Use a bristle brush and solvent to remove grease and fouling from the bolt face, the extractor, the chamber, and the feed ramp. (See the “Care and Cleaning” section of this manual for detailed cleaning instructions).
 - c. Check to see that the magazine rotor spring tension is adequate.
 - d. Check the magazine throat and chamber area to be certain they are free of nicks and burrs and are not deformed.
 - e. Remove excess oil and solvent from all cleaned components, load the magazine, and try the firearm again. As always, proceed slowly. **Be certain bystanders are not close and that you are wearing eye and hearing protection and that your face is a safe distance from the rifle so that any discharge resulting from a jammed cartridge will not injure anyone.**

If the above procedures do not result in a smooth and reliably functioning firearm, don't use the gun. The rifle can be returned directly to our Newport, New Hampshire Product Service Department for repair. See the Service and Parts Policy section, p. 28 of this manual for packing and shipping information.

Another precaution: When using any firearm, form the habit of examining fired cartridge cases. If they have bulged heads or frequently show splits on any part of the case, the rifle or pistol should be returned to the factory for inspection.



WARNING – MALFUNCTIONS



A cartridge can be “discharged” before it is chambered if its primer receives a sharp blow. If a cartridge hangs up, jams, or binds when being chambered or when being fed from the magazine into the chamber, **do not attempt to force it into the chamber by pushing or striking the bolt**. Any jam or feeding problem is a signal to immediately stop using the gun until it can be determined what is wrong. Most failures of a cartridge to feed or to chamber are caused by a damaged magazine, improper gun handling, or defective ammunition. **Whatever the cause, cartridge jams can result in the potentially dangerous situation of a cartridge discharging before it is chambered. If this occurs, the cartridge case will rupture and its fragments will fly out of the gun with sufficient force to cause injury. Always wear shooting glasses and hearing protectors! Keep face away from chamber!**



**STRIKING PRIMER
CAN BURST CARTRIDGE**

BASIC DISASSEMBLY AND REASSEMBLY



WARNING – DISASSEMBLY

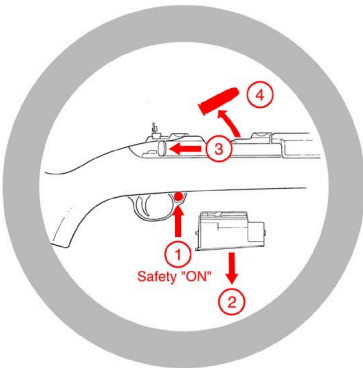

Always **unload** a firearm before cleaning, lubrication, disassembly or assembly.

**UNLOAD BEFORE
CLEANING**

It is preferable to carry out these procedures on a workbench or table which has a covered top. A piece of shallow nap rug or an old, coarse blanket is an ideal covering. Such a covering not only reduces the chances of the rifle slipping and being scratched, but it serves also to trap pins, plungers and springs that may otherwise get lost. It is advisable to have a container - such as a shoebox - in which each part can be placed as it is removed from the gun.

Before attempting to disassemble the rifle for the first time, study the parts drawing and parts list so as to be familiar with the relative position, appearance and name of each part. Carry out the disassembly slowly, and carefully note the position of the part in the gun before starting to remove it. If a part is under spring tension (such as, the Safety Selector, Bolt Stop, Trigger) remove it cautiously and anticipate the direction the spring and plunger are most likely to “jump.”

WARNING: If a spring or plunger become lost, do not use a substitute. Springs of correct tension are vital to the safe and reliable performance of firearms. Before starting disassembly, remove the sling, scope and rings and place the rear sight blade in its down flat position.

DISASSEMBLY

Make Sure Rifle Is Unloaded and Safety is in the “ON” (Safe) Position!

Fold the rear sight down in order to avoid damage during disassembly

1. With the rifle pointing in a safe direction, remove magazine, open the slide and visually make certain there is not a cartridge in the chamber. Then allow the slide to close. The rear sight leaf should be down, and the hammer should be cocked. (See Fig. 7).

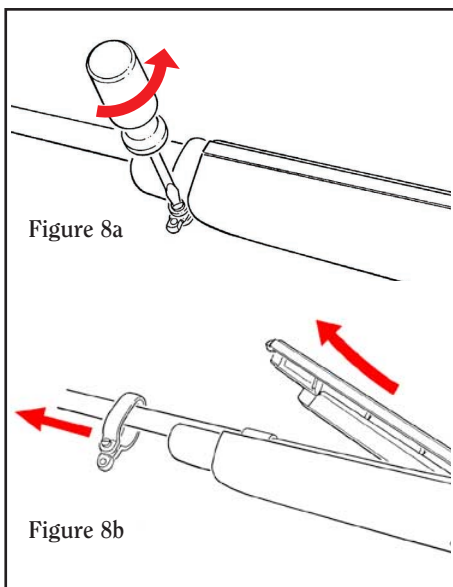
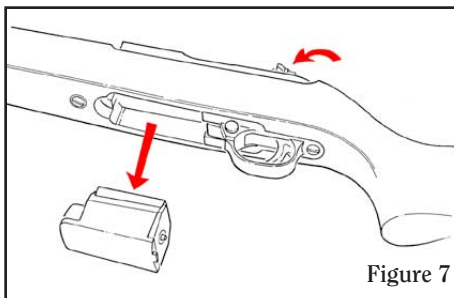

2. Loosen the Barrel Band Screw (B-69) (See Fig. 8a) and remove Barrel Band (CS06800) and Handguard (CS16600). (See Fig. 8b)

3. Remove Trigger Housing Screw (CS04800) (See Fig. 9a) and pivot Trigger Housing (CS01300) forward and out from the stock. (See Fig. 9b).

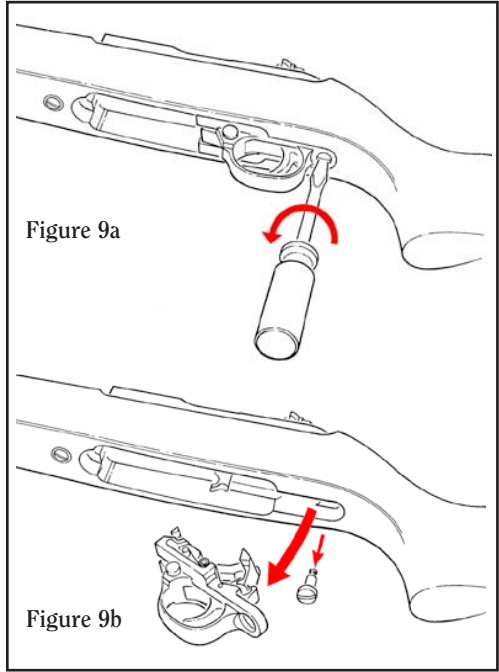

4. Loosen Front Mounting Screw (CS04700). (See Fig. 10)

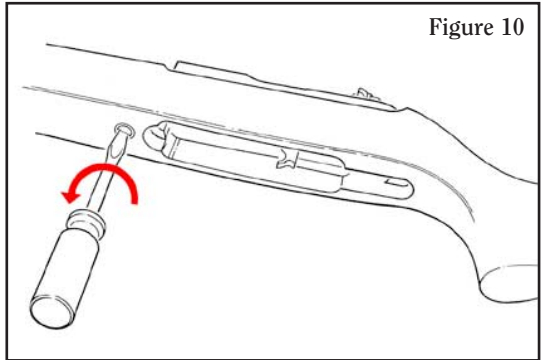

5. Grasp barrel and the fore end of the stock and lift barrel and receiver assembly from stock. (See Fig. 11).

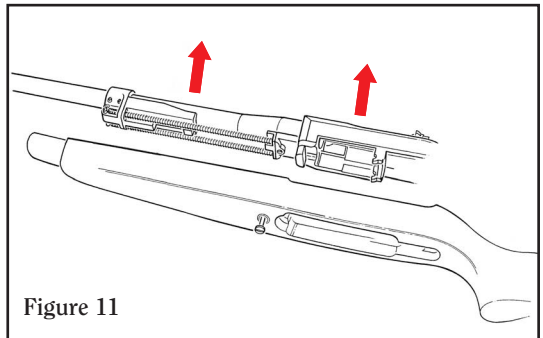

6. Carefully remove Guide Rod Retainer Screw (CS03901) from Gas Block (CS03500) using a small screw driver. (See Fig. 12).

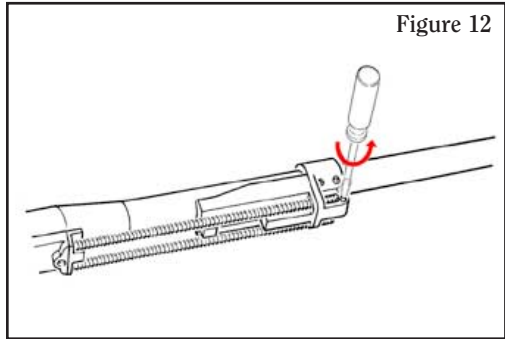

7. Slide the Recoil Spring Guide Rods (CS03900) forward (one at a time) enough to remove the Recoil Springs (CS00601) and Buffer (CS04000). (See Fig. 13).

CAUTION: The springs are heavily compressed - use eye protection and care when disassembling and reassembling to prevent the springs from escaping forcibly and possibly causing injury.

Remove Recoil Spring Guide Rods.

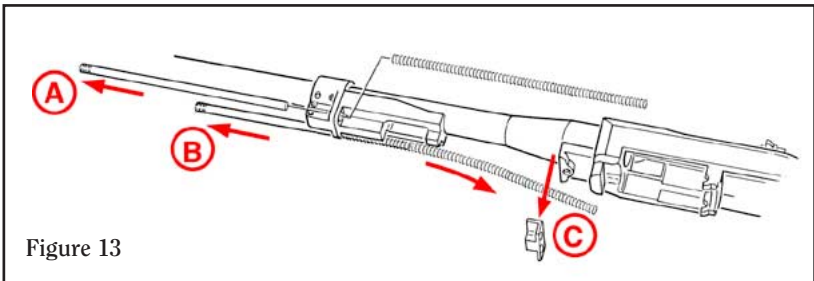

8. Move Slide (CS23701) to the rear to the disassembly notch in the Receiver (CS00101). The slide is now rolled clockwise to disengage it from the Bolt's (CS01000) cam follower and the Receiver. (See Fig. 14).

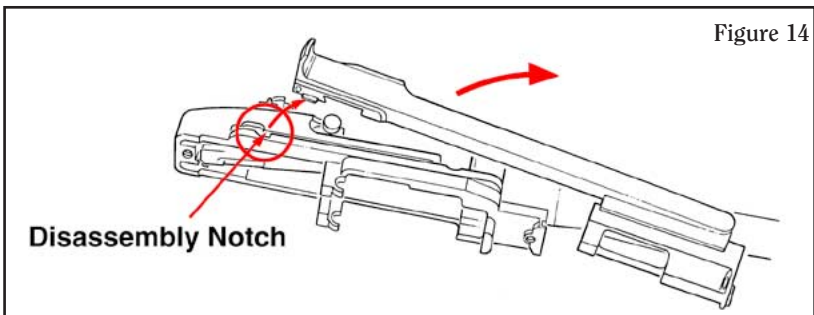

9. Grasp bolt and lift up and forward and rotate in a counterclockwise direction until the rear bolt guide on the back of the bolt enters the disassembly slot. Now rotate the bolt in a clockwise direction and lift bolt from receiver. (See Fig. 15).

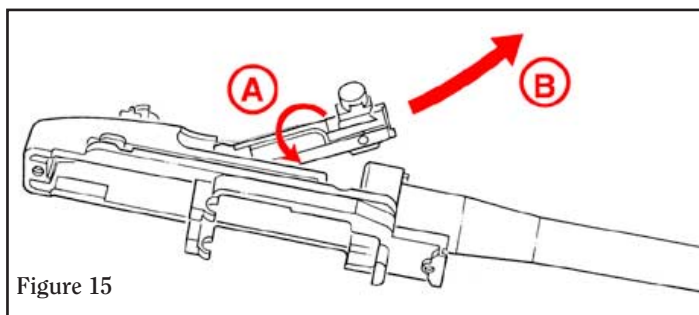

REASSEMBLY

**Again, Make Sure Rifle is Unloaded
and Safety is in the "ON" (Safe) Position!**

1. With the bolt facing forward, insert the rear of the bolt into the disassembly slot of the receiver and align the Firing Pin (KCS01101) projection with the slot in lower receiver bridge. Slowly rotate bolt counterclockwise while sliding bolt into position.
2. With the Bolt in its rearward position, align the Slide handle with the disassembly notch in the rear of the receiver disassembly slot and right-hand Bolt locking lug projection. Rotate the slide counterclockwise to engage the Bolt and Receiver, making sure that the piston end of the Slide is correctly aligned under the barrel. Move Slide to the forward position engaging the Gas Piston (KCS03600).
3. Slide one Recoil Spring Guide Rod through Gas Block and slip one Recoil Spring over it. Compress the spring and then slide the Recoil Spring Guide Rod and Spring Assembly to the rear and insert through the Buffer into the Receiver. Repeat for remaining Recoil Spring Guide Rod. Replace Guide Rod Retainer screw, making sure that it is centrally located on the Gas Block.

CAUTION: *The springs are heavily compressed - use eye protection and care when disassembling and reassembling to prevent the springs from escaping forcibly and possibly resulting in injury.*

4. Replace the assembled barreled action into the stock, making sure that it is fully seated to the rear of the Stock. With a screwdriver, snug down the Front Mounting Screw, but do not tighten completely at this point.
5. Make sure the Hammer (CS01700) is cocked and the Safety is "ON" (safe). To reinstall the Trigger Housing, make sure the assembly lugs on the Trigger Housing engage the assembly notches in the Receiver. Pivot the Trigger Housing into the stock, and then install the Trigger Housing Screw.
6. Now securely tighten both the Front Mounting Screw and the Trigger Housing Screw.
7. Replace the Handguard atop the Barrel.
8. Replace the Barrel Band and tighten its screw securely.
9. Cycle the Slide Handle and Safety a few times to be certain the components are correctly assembled. **Put the Safety back "ON" (safe) and keep it there.**

MAGAZINE INSPECTION AND CARE

Check the magazine frequently. The rotor must move freely and have adequate tension so that each cartridge is quickly raised to the feeding position. The .44 magnum magazine is automatically tensioned (rotor wound 1 1/2 turns) if properly assembled.

To test the rotor tension, load one cartridge into the magazine and then firmly press against the side of the cartridge case. Remove your finger quickly. The cartridge should instantly and fully move in to the feeding position. If it does not, the magazine should be cleaned. **If cleaning does not restore proper rotor tension, do not use the magazine.** (NOTE: After testing, remove the test cartridge).

When cleaning is necessary, use a solvent that will not rust the metal components or adversely affect the plastic magazine box. After the magazine has been soaked in solvent to loosen foreign matter, be certain to shake it vigorously (with the loading opening away from you) to remove solvent or residue from within the magazine.

After cleaning, always check to be certain that rotor movement and tension are correct, and that no solvent or residue remains. Do not disassemble the magazine. **Improper reassembly or improper tensioning of the rotor spring can cause a potentially dangerous malfunction. If you experience a problem with the magazine, don't use it. Get a new one.**

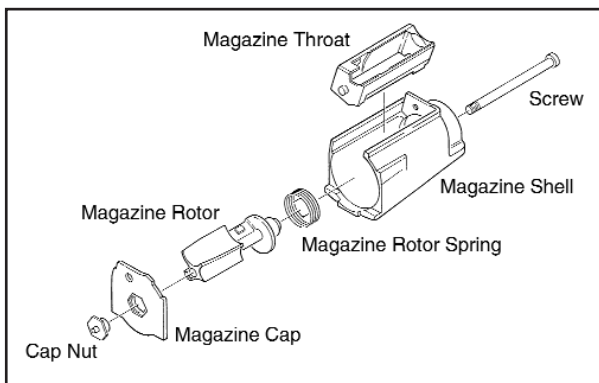

Exploded view of the magazine components. This illustration is included to show the relationship and names of the magazine components. As noted in the text above, the magazine should not be disassembled.

DAMAGED, NON-STANDARD, OR IMPROPERLY ASSEMBLED MAGAZINES SHOULD NOT BE USED. THEY CAN CAUSE THE RIFLE TO MALFUNCTION.

CARE AND CLEANING

Make Sure Gun is Unloaded!



Before cleaning, be certain the rifle and its magazine contain no cartridges.

At regular intervals, or whenever the rifle has been exposed to sand, dust, extreme humidity, condensation, immersion in water, or other adverse conditions, disassemble, clean and oil it. Proper periodic maintenance is essential to the reliable functioning of any firearm.

To clean the rifle, proceed as follows:

1. Disassemble (field-strip) the rifle to the extent described on pages 18 - 21.
2. Using a cleaning rod, run a solvent-wetted patch through the bore several times. Then attach a solvent-wetted bristle brush to the rod and run it back and forth the full length of the bore as many times as necessary to remove grease and dirt from the bore and chamber. Clean bore with dry patches and examine. Bore fouling can contribute to reduced accuracy, and grease accumulation in the chamber can interfere with proper feeding of cartridges from the magazine.
3. Using powder solvent on a clean patch or bristle brush, remove powder residue from all components of the mechanism. After cleaning, run a dry patch through the bore, then follow with a patch that is very lightly oiled. Wipe all surfaces clean with cloth, then wipe all surfaces with a patch or cloth that has been very lightly oiled.

4. NOTE: Only a light application of oil is needed to provide adequate lubrication of moving parts and to prevent rust. Excess accumulations of oil tend to attract particles of dust and dirt and may congeal in cold weather which can interfere with the safe and reliable functioning of the rifle.

 WARNING – LUBRICATION	
	<p>Firing a rifle with oil, grease, or any other material even partially obstructing the bore may result in damage to the rifle and serious injury to the shooter and those nearby. Do not spray or apply lubricants directly on ammunition. If the powder of a cartridge is affected by the lubricant, it may not be ignited, but the primer firing may push the bullet into the bore where it may be lodged. Firing a subsequent bullet into the obstructed bore may damage the rifle and cause serious injury or death to the shooter and those nearby. Use lubricants properly. You are responsible for the proper care and maintenance of your firearms.</p>
IMPROPER LUBRICATION DESTROYS GUNS	

STORAGE

GUNS SHOULD NOT BE STORED LOADED!

**USE THE LOCKING DEVICE SUPPLIED WITH THE RIFLE FOR STORAGE.
(SEE PAGE 3)**

Do not store the rifle in a leather case or scabbard. Leather attracts moisture, even though it may appear to be dry.

TO RENDER THE RIFLE INOPERATIVE FOR SAFE STORAGE

With the muzzle pointed in a safe direction, remove the magazine, open the bolt, and check the chamber to be sure the rifle is completely unloaded! Remove the trigger housing screw and pivot the trigger housing forward and out of the stock. The trigger housing assembly contains most of the firing mechanism.

Store the rifle and the trigger housing assembly in different locations. When disassembled in this manner, the rifle is inoperable. It is impossible to fire the rifle until the trigger housing assembly has been correctly replaced into the rifle.

To reassemble the rifle for firing, reinstall the trigger housing and replace the trigger housing screw to secure the trigger housing to the receiver. Check to be sure the bolt, trigger, and safety mechanisms can be operated fully and freely. The rifle is now reassembled and can be loaded and fired normally.

While the rifle is less likely to be used by unauthorized persons when disassembled in the above manner, it is always safest to store a firearm with the supplied locking device correctly installed, or to store the firearm in a gun safe or other secure location, away from children and unauthorized adults. Guns should always be stored securely, unloaded and separate from their ammunition.

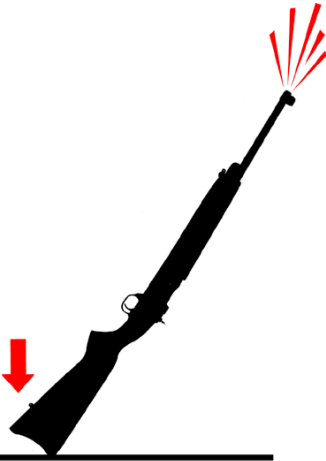
 WARNING – STORAGE	
	<p>Never place or store any firearm in such a manner that it may be dislodged. Firearms should always be stored securely and unloaded, away from children and careless adults. Use the locking device originally supplied with this firearm for storage.</p> <p>The use of a locking device or safety lock is only one aspect of responsible firearms storage. For increased safety, firearms should be stored unloaded and locked in a location that is both separate from their ammunition and inaccessible to children and any other unauthorized person.</p>
STORE SECURELY & UNLOADED	

ATTACHING RUGER SCOPE RINGS

Each Ruger telescope ring is a mated assembly of a top and a base. Do not mix the parts of the two ring assemblies as they are not interchangeable. On the underside of each mounting ring assembly there is an integral lug, located off center with respect to the front and back sides of the mount. The lug is nearer to the front surface. By reference to the lug, the mounting ring can be correctly assembled with the front of the ring toward the muzzle of the rifle.

1. Disassemble one ring and reassemble over the scope body between the turret and the eyepiece. Remember - the lug on the base should be on the front side of the scope.
2. Install the four top screws. Do not tighten.
3. Disassemble the other ring and install it on the forward section of the scope tube with the lug forwardly also. Install the four top screws. Again, do not tighten.
4. Assemble the rings to the receiver with the lugs engaging the recesses in the top surface of the receiver. Tighten the clamp nuts so that the rings are locked to the semicircular cuts on the sides of the receiver.
5. Rotate the scope until cross-hairs are aligned properly and slide scope to desired eye relief. then tighten the eight top screws each a bit at a time to grip the scope body.
6. Sight in according to the directions with your scope.
7. If ejected cases strike the scope, try using higher scope rings or different ammunition. If this condition persists, you should use the supplied Ruger Scope Shield (part no. SP17339).

SIGHT ADJUSTMENT

Shooting to determine the setting of the elevation slide (aperture) should be done from a bench rest and over a measured distance.

Since the impact point and accuracy of different .44 magnum ammunition can vary considerably (a 180 grain bullet load may impact the target 15" higher than a 300 grain bullet load at 50 yards), to accommodate the majority of ammunition the open sights are factory zeroed at 50 yards with standard U.S. factory-loaded 240 grain jacketed bullet ammunition.

SUGGESTED SIGHT PICTURE

The front sight is aligned in the center of the rear sight aperture ("peep") and the target (bullseye) is positioned to appear as if it is sitting on top of the front sight.

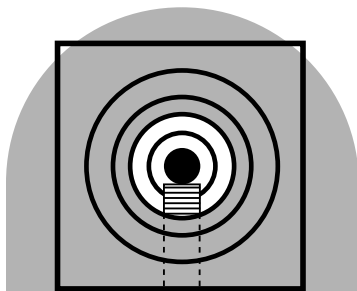

The rear sight is adjustable for both windage and elevation. Lateral (windage) adjustment is made by loosening the Rear Sight Windage Lock Screw (with the hex-head wrench provided with the rifle) until the sight base requires finger pressure to be moved. (See illustration below). Move the sight in the direction you wish to move the point of impact. Before moving the sight, pencil mark an index line on the sight base and on the receiver so that the amount of sight movement can be detected. After desired positioning of the sight base has been achieved, tighten the lock screw firmly.

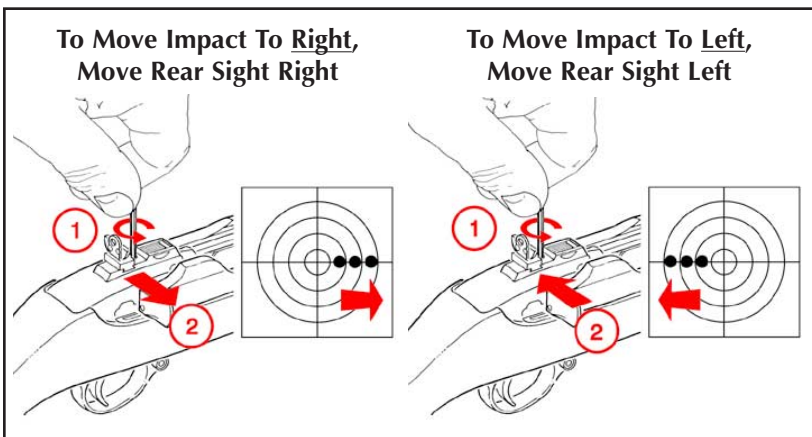

WINDAGE ADJUSTMENT: Loosen windage lock screw. To move the bullet impact point to the left, move the rear sight base to the left. To move the bullet impact point to the right, move the rear sight base to the right. Be sure to carefully retighten lock screw after adjustment.

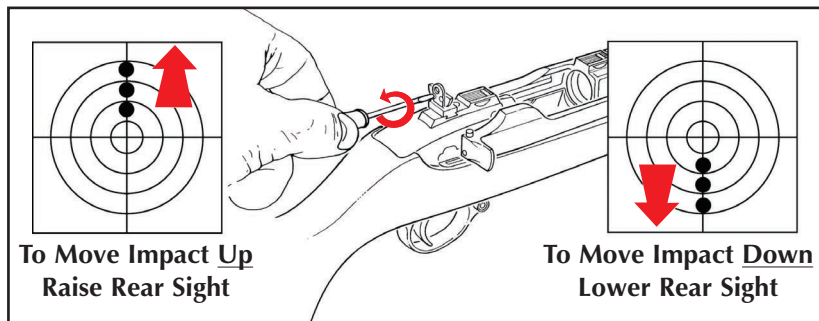

ELEVATION ADJUSTMENT: To move the bullet impact point up or down, move the elevation slide (the “peep”) by loosening both elevation lock screws (using a small screwdriver with a blade tip that exactly fits the screw-heads) only slightly so the slide doesn’t move too freely. Move the slide in the direction you want the point of impact of the bullet to move. When the slide is positioned at the desired height, be sure to carefully retighten both screws.

SERVICE AND PARTS POLICY

If you have any question with regard to the performance of your **RUGER® DEERFIELD® CARBINE** please write or call (603-865-2442) our Product Service Department in Newport, New Hampshire 03773, fully describing all circumstances and conditions involved. If you should return your rifle to the factory for repair, or order parts for it, please comply with the following suggestions for prompt service:



WARNING: BEFORE SHIPPING ANY FIREARM, BE ABSOLUTELY CERTAIN THAT IT AND ITS MAGAZINE ARE UNLOADED. DO NOT SHIP CARTRIDGES WITH A FIREARM.

SHIPPING FIREARMS FOR REPAIR

RUGER® DEERFIELD® CARBINE's returned to the factory for repair should be sent to: Sturm, Ruger & Company, Inc., Product Service Department, 411 Sunapee St., Newport, New Hampshire 03773. Telephone (603) 865-2442.

Guns should be sent prepaid. We will not accept collect shipments.

The Federal Gun Control Act, as well as the laws of most States and localities, do not prohibit an individual (who is not otherwise barred from purchasing or possessing a firearm) from shipping a firearm directly to the manufacturer for repair. However, before you ship your rifle to us, be certain that your State or locality does not have a law or regulation which will prohibit you from receiving the rifle from us after it has been repaired. If such receiving is prohibited, then please have a Federally Licensed firearms dealer ship the gun to us. If your rifle is sent to us by a dealer, it will be returned to him after being repaired. If a handgun (pistol or revolver) is shipped by an individual who does not hold a Federal Firearms License, it must be shipped via U.P.S. (Next Day Air). Persons who do not hold a Federal Firearms License are prohibited by Federal law from shipping a handgun by Mail. Handguns mailed in violation of the law are impounded by the Post Office.

DO NOT SEND GUN BOXES OR LITERATURE THAT YOU CONSIDER TO BE COLLECTOR'S ITEMS – THESE ARE INVARIABLY DAMAGED OR DESTROYED IN SHIPMENT. Please do not include rifle case, sling, telescopic sights or custom accessories with a firearm being shipped to the factory for service. Rifles and shotguns may be shipped via Parcel Post. Always insure your shipment.

Enclose a letter which includes your name, address, telephone number, serial number and model of the firearm. Describe in detail the trouble you have experienced with your firearm, or the work you wish to have done. Merely stating that the firearm "needs repair" is inadequate information.

Work performed will bear a net minimum labor charge of \$20.00 plus a \$12.00 shipping and handling charge. The charge for rebluing the **RUGER® DEERFIELD® CARBINE** is \$50.00 plus a \$12.00 shipping and handling charge. Custom gunsmithing service or nonstandard alterations are NOT AVAILABLE from Ruger Product Service Departments.



WARNING – PARTS PURCHASERS



It is the purchaser's responsibility to be absolutely certain that any parts ordered from the factory are correctly fitted and installed. Firearms are complicated mechanisms and **IMPROPER FITTING OF PARTS MAY RESULT IN A DANGEROUS MALFUNCTION, DAMAGE TO THE FIREARM, AND SERIOUS INJURY TO THE SHOOTER AND OTHER PERSONS.** The purchaser and installer of parts must accept full responsibility for the correct adjustment and functioning of the rifle after such installation.

PARTS MUST FIT CORRECTLY

ORDERING PARTS

Please contact the New Hampshire Product Service Department for parts availability and current prices. All parts orders for the **RUGER® DEERFIELD® CARBINE** should be sent to: Sturm, Ruger & Co., Inc., Product Service Department, 411 Sunapee Street, Newport, New Hampshire 03773, 603-865-2442. We cannot comply with open account or C.O.D. orders. Payment in the form of a check, money order, Visa or Mastercard must accompany your order. Credit Card orders must include the account number, expiration date and whether it is a Visa or Mastercard account. Minimum parts order is \$1.00 plus \$3.50 shipping and handling charge. Order parts by Part Name and Part Number and include the entire serial number of the firearm for which the parts are being ordered. There is a minimum net labor charge of \$20.00 plus \$12.00 shipping and handling charge if the parts are factory fitted. All factory fitted parts are fit on an exchange basis only. We will not return the replaced parts.

Barrels, and a number of other component parts must be fitted at the factory. Company policy is to proof-test and/or function fire all barrels after fitting to the receivers in which they are to be used. This procedure ensures maximum protection to our customers. The special proof-test ammunition used in this testing is sold only to bonafide firearms manufacturers and is not available to gun shops, gunsmiths, or individuals.

Because the receiver of the **RUGER® DEERFIELD® CARBINE** is a serial numbered component, it is defined as a "firearm" by Federal law and is not sold as a separate component.

*Parts designated by an asterisk must be factory fitted. These parts are fitted on an exchange basis only. We will not return the replaced parts. We will not return any part that is broken, malfunctioning, badly worn or has been modified. See "Warning – Parts Purchasers", above.



CAUTION: A gun containing modified, broken, malfunctioning, or badly worn parts should not be fired.

RUGER® DEERFIELD® CARBINE

PARTS LIST

Design, prices and specifications subject to change without notice.

SPECIFY MODEL & SERIAL NUMBER WHEN ORDERING

(See Exploded View on Page 33)

Part Name	Part No.	Model
* Barrel	0C8001	99/44
Barrel Band	CS06800	99/44
Barrel Band Screw	B-69	99/44
Bolt Only	CS01000	99/44
* Bolt Assembly, Complete	CS01001	99/44
Buffer	CS04000	99/44
Butt Plate	C-63	99/44
Butt Plate Screw, 2 Req'd.	B-64	99/44
Cable Lock, 10" - For Ruger Rifles <i>Only</i>	PM120A	99/44
Extractor	CS01400	99/44
Extractor Plunger	KCS01600	99/44
Extractor Spring	MS01500	99/44
* Firing Pin	KCS01101A	99/44
Front Mounting Screw	CS04700	99/44
Front Sight, With Gold Bead	B27501	99/44
Front Sight Base	CS04400	99/44
Front Sight Cross Pin	MS07200	99/44
* Gas Block	CS03500	99/44

Part Name	Part No.	Model
Gas Block Cross Pin, Outer, 3 Req'd	CS06100	99/44
Gas Block Cross Pin, Inner, 2 Req'd	CS06200	99/44
Gas Pipe	KCS03600	99/44
Guide Rod, 2 Req'd	CS03900	99/44
Guide Rod Retainer Screw	CS03901	99/44
* Hammer	CS01700	99/44
Hammer Pivot Pin	L02600	99/44
Hammer Spring, Left	L01810	99/44
Hammer Spring, Right	L01800	99/44
Hammer Spring Support Pin	L02500	99/44
Handguard	CS16600	99/44
Magazine, Complete, 4-Shot Capacity	CS22706	99/44
Magazine Latch	CS03101	99/44
Magazine Latch Plunger	CS03620	99/44
Magazine Latch Spring	CS05000	99/44
Rear Sight Assembly	MS25501	99/44
Rear Sight Windage Lock	MS05910	99/44
Rear Sight Windage Lock Screw	MS05710	99/44
Recoil Spring, 2 Req'd	CS00601	99/44
Safety Button	CS05200	99/44
Safety Detent Plunger	B-53	99/44
Safety Detent Plunger Spring	B-54	99/44
Scope Protector, Complete (Not Illustrated)	SP17339	99/44

Part Name	Part No.	Model
Scope Rings, High Rings Accomodate 52mm Lens	S100RH	99/44
Scope Ring Clamp	D-74	99/44
Scope Ring Nut	D-73	99/44
Scope Ring Screws, 8 Req'd	D-76	99/44
* Secondary Sear	CS02300	99/44
Secondary Sear Spring	S-41	99/44
Slide	CS23701	99/44
Slide Spring	D-32	99/44
Slide Lock Plunger	CS04500	99/44
Sling Swivel Adapter	B08600	99/44
Sling Swivel Stud, Rear	S-87	99/44
Stock Assembly, Complete	CS00400	99/44
* Trigger	CS02000	99/44
Trigger Housing	CS01300	99/44
Trigger Housing Screw	CS04800	99/44
Trigger Pivot Pin	B-21	99/44
Trigger Spring	CS02400	99/44

* PARTS SO MARKED MUST BE FACTORY FITTED

THE BASIC RULES OF SAFE FIREARMS HANDLING

We believe that Americans have a right to purchase and use firearms for lawful purposes. The private ownership of firearms in America is traditional, but that ownership imposes the responsibility on the gun owner to use his firearms in a way which will ensure his own safety and that of others. When firearms are used in a safe and responsible manner, they are a great source of pleasure and satisfaction, and represent a fundamental part of our personal liberty.

Firearms do not cause accidents! Firearms accidents are almost always found to have been the result of carelessness, or ignorance on the part of the shooter of the basic rules of safe gun handling.

The following rules must be observed by gun users at all times. Safe gun handling is not just desirable, it is absolutely essential to your safety, the safety of others, and the continuation of gun ownership and sport shooting as we know it today.

1. LEARN THE MECHANICAL AND HANDLING CHARACTERISTICS OF THE FIREARM YOU ARE USING.

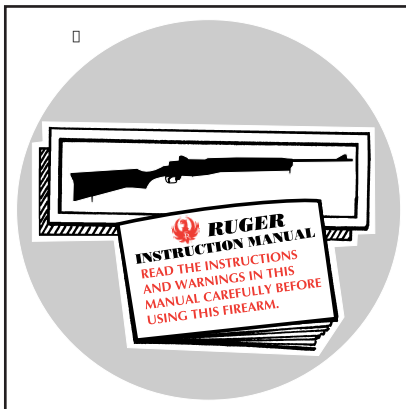

Not all firearms are the same. The method of carrying and handling firearms varies in accordance with the mechanical provisions for avoiding accidental discharge and the various proper procedures for loading and unloading. No person should handle any firearm without first having thoroughly familiarized himself with the particular type of firearm he is using, and with safe gun handling in general.

2. ALWAYS KEEP THE MUZZLE POINTED IN A SAFE DIRECTION.



Be sure of the bullet stop behind your target, even when dry-firing. Never let the muzzle of a firearm point at any part of your body or at another person. This is particularly important when loading or unloading a firearm. In the event of an accidental discharge, no injury can occur as long as the muzzle is pointing in a safe direction. A safe direction means a direction which will not permit a discharged bullet to strike a person, or to strike an object from which the bullet may ricochet.

A safe direction must take into account the fact that a bullet may penetrate a wall, ceiling, floor, window, etc., and strike a person or damage property. Make it a habit to know exactly where the muzzle of your gun is pointing whenever you handle it, and be sure that you are always in control of the direction in which the muzzle is pointing, even if you fall or stumble. Keep your finger off the trigger until you are ready to shoot.

3. FIREARMS SHOULD BE UNLOADED WHEN NOT IN USE.

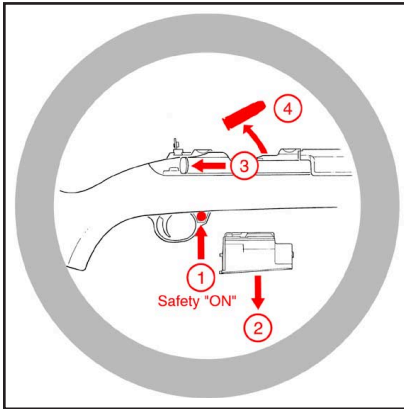

Firearms should be loaded only when you are in the field or on the target range or shooting area, ready to shoot. Firearms and ammunition should be securely locked in safes, racks or cabinets, or by using the locking device supplied with the firearm, when not in use. Ammunition should safely be stored separate from firearms. Store your firearms out of sight of visitors and children. It is the gun owner's responsibility to be certain that children and

persons unfamiliar with firearms cannot gain access to firearms, ammunition, or components.

4. BE SURE THE BARREL IS CLEAR OF OBSTRUCTIONS BEFORE SHOOTING.

Even a bit of mud, snow or excess lubricating oil or grease in the bore may cause the barrel to bulge, or even burst on firing, and can cause serious injury to the shooter and bystanders. Be sure that you are using ammunition of the proper caliber and loading for the gun you are using. If the report or recoil on firing seems weak, or doesn't seem quite right, **CEASE FIRING IMMEDIATELY**, unload your firearm, and check to be sure that no obstruction has become lodged in the barrel. Never try to shoot out an obstruction!

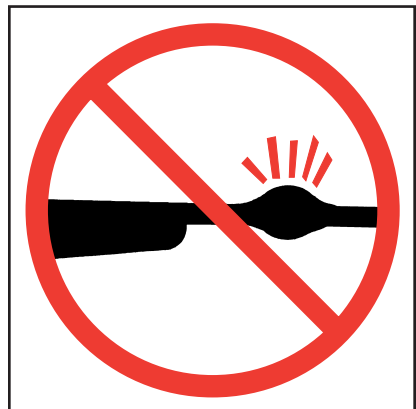



5. BE SURE OF YOUR TARGET BEFORE YOU SHOOT.

Don't shoot unless you know exactly where your bullet is going to strike. Be sure of the bullet stop behind your target, even when dry-firing with an unloaded gun. If you are in the field hunting, do not fire at a movement or noise. Take the time to be absolutely certain of your target before you pull the trigger.

6. WEAR SHOOTING GLASSES AND HEARING PROTECTORS WHEN YOU SHOOT.

All shooters should wear protective shooting glasses and adequate hearing protectors when shooting. Exposure to shooting noise can damage hearing, and adequate eye protection when shooting is essential.



7. NEVER CLIMB A TREE OR FENCE WITH A LOADED FIREARM.

Put the firearm down carefully before climbing a fence, and unload it before climbing or descending a tree or jumping over a ditch or other obstruction. Never pull or push a loaded firearm toward yourself or another person. When in doubt, or whenever you are about to do anything awkward, unload your gun!

8. DON'T SHOOT AT A HARD SURFACE, OR AT WATER.

Bullets can glance off many surfaces like rocks or the surface of water and travel in unpredictable directions with considerable velocity.

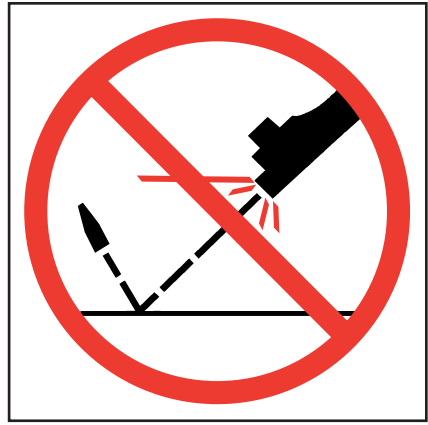

9. NEVER TRANSPORT A LOADED FIREARM.

Firearms should always be unloaded before being placed in a vehicle. A suitable carrying case or scabbard should be used to carry an unloaded firearm to and from the shooting area.

10. AVOID ALCOHOLIC BEVERAGES WHEN SHOOTING.

Don't drink until the day's shooting is over. Handling firearms while under the influence of alcohol in any form, or medications that could affect your judgement or co-ordination, constitutes a criminal disregard for the safety of others.



A BRIEF ACCOUNT OF AN EXTRAORDINARY ACHIEVEMENT: RUGER FIREARMS

One of the few American firearms manufacturers whose management has remained unchanged since starting in business, Sturm, Ruger & Company, Inc., had its beginning in a small machine shop occupying a rented frame building in Southport, Connecticut. In January, 1949, with an initial investment of only \$50,000 and an idea, William B. Ruger and Alexander M. Sturm started production of a .22 caliber autoloading pistol – a design which was so successful that it became the cornerstone upon which one of the most comprehensive lines of sporting firearms ever made in America was established. After Alex Sturm's death in 1951, William B. Ruger continued to direct the company alone and today, as Chairman Emeritus of the Board, he continues to provide the guidance which has made this 52-year-old company a sound and successful enterprise.

Sturm, Ruger & Company, in this relatively short time, has established itself as a leading small arms design organization, developing a unique and broad line of fine quality sporting, military and police firearms to become one of the world's most famous producers of revolvers, pistols, rifles and shotguns. From 1949 thru 2001 Ruger craftsmen have built many millions of firearms.

During its five decades of growth and progress under the leadership of William B. Ruger, the company has developed a business philosophy and implemented policies which represent a constructive influence in the life of modern America. From the beginning, Sturm, Ruger & Company played a positive role in conservation efforts and has supported the interests of shooters through such groups as the National Rifle Association, National Shooting Sports Foundation, and many regional sportsmen's organizations. The company has always endeavored to market its firearms for constructive and recreational purposes, to emphasize the traditional aspects of shooting, to render meaningful public services and to encourage shooters in constructive, responsible, and safe participation in the shooting sports.

Today, Sturm, Ruger & Company is particularly mindful of those elements which have contributed to the creation of its success, and extends heartfelt thanks to its many loyal employees and customers.

A current catalog of Ruger firearms is available free upon request to
Sturm, Ruger & Co., Inc., Southport, CT 06490.

WHY NO WARRANTY CARD HAS BEEN PACKED WITH THIS NEW RUGER FIREARM

The Magnuson-Moss Act (Public Law 93-637) does not require any seller or manufacturer of a consumer product to give a written warranty. It does provide that if a written warranty is given, it must be designated as "limited" or as "full" and sets minimum standards for a "full" warranty. Sturm, Ruger & Company, Inc. has elected not to provide any written warranty, either "limited" or "full", rather than to attempt to comply with the provisions of the Magnuson-Moss Act and the regulations issued thereunder. There are certain implied warranties under state law with respect to sales of consumer goods. As the extent and interpretation of these implied warranties varies from state to state, you should refer to your state statutes. Sturm, Ruger & Company wishes to assure its customers of its continued interest in providing service to owners of Ruger firearms.



STURM, RUGER & Company, Inc.
Southport, Connecticut 06490 U.S.A.
<http://www.ruger.com>

“Arms Makers For Responsible Citizens”[®]

**A COPY OF THE INSTRUCTION MANUAL FOR ANY RUGER
FIREARM IS AVAILABLE FROM THE FACTORY FREE ON REQUEST.
THESE INSTRUCTION MANUALS CONTAIN IMPORTANT
WARNINGS WHICH MUST BE UNDERSTOOD
BEFORE USING THESE FIREARMS.**

“RUGER”, the Sturm, Ruger logo, “SINGLE-SIX”, “BLACKHAWK”, “REDHAWK”, “SECURITY-SIX”, “SPEED-SIX”, “SERVICE-SIX”, “BEARCAT”, “OLD ARMY”, “10/22”, “MINI-14”, “MINI THIRTY”, “RANCH RIFLE”, “M77”, “77/22”, “77/44”, “77/50”, “GP-100”, “SP101”, “P-85” and “VAQUERO” are registered U.S. trademarks.

“77/17” & “Gold Label” are Ruger trademarks.